

Heyco®  
Hole Plugs and Venting  
Solutions  
- 2018 -

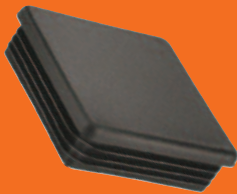

a PennEngineering® Company





CONTENTS

Heyco® Dome Plugs ..... 6-25

Heyco® Large and Thick Panel Dome Plugs ..... 6-26

Heyco® Shorty Plugs ..... 6-27

Heyco® Thin Panel Dome Plugs ..... 6-28

Heyco® Halogen and Phosphorus-Free 94V-0 Hole Plugs ..... 6-29

Heyco® Extra Dome Plugs ..... 6-30

Heyco® Snap-In Metric Dome Plugs ..... 6-30

Heyco® Glossy and Thick Panel Glossy Plugs ..... 6-31

Heyco® Pry Out Plugs - Standard and Prong Finger Designs ..... 6-32

Heyco® Metric Ergonomic Plugs ..... 6-33

Heyco® Insulation Plug ..... 6-33

Heyco® Double D Hole Plugs ..... 6-34

Heyco® Rectangular Blanking and Connector Port Plugs ..... 6-34

Heyco® Window “View Port” Plugs ..... 6-35

Heyco® Diffuser Plugs ..... 6-35

Heyco® Shorty and Oval Window “View Port” Plugs ..... 6-36

Heyco® Knock-Out Seals and Thick Panel Knock-Out Seals ..... 6-37

Heyco® Nylon V-0 Knock-Out Seals ..... 6-37

Heyco® V-0 Liquid Tight Hole Plugs - Standard 85 and Low 75 Durometer Plugs ..... 6-38

Heyco® Nylon Liquid Tight Threaded Plugs ..... 6-39

HEYCo-molded™ Liquid Tight Break-Thru Plugs ..... 6-40

HEYCap™ D-Subminiature and Electro Miniature Protection Caps ..... 6-41

Heyco® Nylon D-Subminiature Mounting Hole Plugs ..... 6-42

Heyco® IEC-14 Plug ..... 6-42

Heyco® Connector Caps and Plugs ..... 6-43

Heyco® PG and Metric Threaded Plugs - Plastic and Nickel-Plated Brass ..... 6-44

Heyco® Threaded Plugs for Threaded Ports – NPT, NPS, SAE and ISO ..... 6-45

Heyco® Push-In Threaded Plugs for SAE and NPT Threaded Ports ..... 6-46

Heyco® TEMPlugs™ for NPT Threaded Ports ..... 6-46

HEYCap™ Tapered Plugs and Caps – NPT & SAE ..... 6-47, 6-48

Heyco® LDPE Sheet Metal Plugs – Recessed and Flush Head ..... 6-49

HEYCaps™ and Plugs for Round Tubing – Clearance and Ribbed Fit ..... 6-50

Heyco® Plugs for Square Tubing – Clearance and Ribbed Fit ..... 6-51

Heyco® Ergonomic Plugs for Square Tubing – Vinyl ..... 6-52

Heyco® Plugs for Rectangular Tubing – Ribbed Fit ..... 6-52

Heyco® Stock and Custom Colors for Dome Plugs and Shorty Plugs ..... 6-53

Heyco® Vent Plugs and Thick Panel Vent Plugs ..... 6-54

HEYClean™ Filter Insert Vent Plugs ..... 6-55

Heyco® Louvered Plugs ..... 6-56

HEYClean™ Filter Insert Louvered Plugs ..... 6-56

Heyco® Threaded Vent Plugs ..... 6-57

HEYClean™ Liquid Tight Threaded Vent Plugs ..... 6-58

HEYClean™ Liquid Tight Snap-In Vent Plugs ..... 6-58

HEYClean™ Brass Pressure Equalization and Drain Plugs ..... 6-59

HEYClean™ Drain Plug Brass Locknuts ..... 6-59

“Stay Connected” with



Hole Plugs & Venting Solutions

a PennEngineering® Company

# Ask About Heyco® LabKits

## Heyco® Hole Plugs LabKit #3 (Part No. 2997)

### Use Heyco LabKits!

- Heyco LabKits are perfect for product design departments, experimental labs, and for all prototype work.
- Heyco Kits contain an assortment of our most popular plugs.
- Heyco also offers LabKits for Liquid Tight Cordgrips, Strain Relief Bushings, Bushings, Hardware, Power Components, and Grommets.





- Close unneeded panel holes and electrical knockouts.
- Quick and easy installation.
- Convex, matte finish head tapers to thin edge (Except DP-187).
- Multiple sizes for use in .187" (4,7 mm) to 6.000" (152,4 mm) diameter holes.
- Lock firmly into panel up to .250" (6,4 mm) thick.
- Locking fingers in fractional increments up to the maximum panel thickness.
- Approximate Head Thickness: .062" (1,6 mm). Thickness may vary.
- For Snap-In Metric Dome Plugs see page 6-30.

## Heyco® Dome Plugs

Mounting Hole Diameter Range: .187" (4,7 mm) to 2.500" (63,5 mm)

| MOUNTING HOLE DIAMETER                                       |     | PART NO.                   |                            |                  | DESCRIPTION           | PART DIMENSIONS    |     |                     |     |
|--|-----|----------------------------|----------------------------|------------------|-----------------------|--------------------|-----|---------------------|-----|
| in.  | mm. | Black                      | White                      | Colors xx**      |                       | A<br>Head Diameter |     | B<br>Overall Height |     |
| Single Locking Step for Panel Thickness up to .062" (1,6 mm) |     |                            |                            |                  |                       |                    |     |                     |     |
| .187   | 4,7 | <b>2590</b>                | <b>2591</b>                | 2592xx           | DP 187*               | .25                | 6,4 | .23                 | 5,9 |
| .250   | 6,4 | <b>2607</b><br><b>2603</b> | <b>2608</b><br><b>2604</b> | 2609xx<br>2605xx | DP 250-040†<br>DP 250 | .31                | 7,9 | .31                 | 7,9 |
| .312   | 7,9 | <b>2613</b>                | <b>2614</b>                | 2615xx           | DP 312                | .38                | 9,5 |                     |     |

Multiple Locking Steps for Panel Thickness up to .125" (3,2 mm)

|               |             |             |             |        |         |      |      |     |      |
|---------------|-------------|-------------|-------------|--------|---------|------|------|-----|------|
| .375          | 9,5         | <b>2617</b> | <b>2618</b> | 2619xx | DP 375  | .47  | 11,9 | .41 | 10,3 |
| .437          | 11,1        | <b>2633</b> | <b>2634</b> | 2635xx | DP 437  | .53  | 13,5 |     |      |
| .500          | 12,7        | <b>2643</b> | <b>2644</b> | 2645xx | DP 500  | .56  | 14,2 |     |      |
| .562          | 14,3        | <b>2653</b> | <b>2654</b> | 2655xx | DP 562  | .66  | 16,7 |     |      |
| .625          | 15,9        | <b>2663</b> | <b>2664</b> | 2665xx | DP 625  | .72  | 18,2 |     |      |
| .687          | 17,4        | <b>2673</b> | <b>2674</b> | 2675xx | DP 687  | .78  | 19,8 |     |      |
| .750          | 19,1        | <b>2683</b> | <b>2684</b> | 2685xx | DP 750  | .92  | 23,4 |     |      |
| .812          | 20,6        | <b>2693</b> | <b>2694</b> | 2695xx | DP 812  | .99  | 25,1 |     |      |
| .875          | 22,2        | <b>2703</b> | <b>2704</b> | 2705xx | DP 875  | 1.02 | 25,8 | .45 | 11,5 |
| 1.000         | 25,4        | <b>2713</b> | <b>2714</b> | 2715xx | DP 1000 | 1.20 | 30,6 |     |      |
| 1.093 - 1.125 | 27,8 - 28,6 | <b>2723</b> | <b>2724</b> | 2725xx | DP 1093 | 1.22 | 30,9 |     |      |
| 1.187         | 30,1        | <b>2733</b> | <b>2734</b> | 2735xx | DP 1187 | 1.33 | 33,8 |     |      |
| 1.250         | 31,7        | <b>2740</b> | <b>2741</b> | 2742xx | DP 1250 | 1.38 | 34,9 |     |      |
| 1.375         | 34,9        | <b>2753</b> | <b>2754</b> | 2755xx | DP 1375 | 1.50 | 38,1 |     |      |
| 1.500         | 38,1        | <b>2763</b> | <b>2764</b> | 2765xx | DP 1500 | 1.67 | 42,4 |     |      |
| 1.625         | 41,3        | <b>2276</b> | <b>2277</b> | 2278xx | DP 1625 | 1.80 | 45,7 |     |      |
| 1.750         | 44,5        | <b>2773</b> | <b>2774</b> | 2775xx | DP 1750 | 1.92 | 48,7 |     |      |
| 1.875         | 47,6        | <b>2291</b> | <b>2292</b> | 2293xx | DP 1875 | 2.05 | 52,1 |     |      |
| 2.000         | 50,8        | <b>2783</b> | <b>2784</b> | 2785xx | DP 2000 | 2.17 | 55,1 | .47 | 11,9 |

**NEW!**

**NEW!**

Multiple Locking Steps for Panel Thickness up to .250" (6,4 mm)

|               |             |             |             |        |          |      |      |     |      |
|---------------|-------------|-------------|-------------|--------|----------|------|------|-----|------|
| 2.093 - 2.125 | 53,2 - 54,0 | <b>2403</b> | <b>2404</b> | ***    | DP 2.093 | 2.34 | 59,9 | .75 | 19,1 |
| 2.250         | 57,2        | <b>2411</b> | <b>2412</b> | 2413xx | DP 2.25  | 2.48 | 63,0 | .75 | 19,1 |
| 2.500         | 63,5        | <b>2790</b> | <b>2791</b> | 2792xx | DP 2.5   | 2.71 | 68,8 |     |      |

Standard colors black and white. Consult Heyco for other colors (see below)

\*Convex, glossy finish head.

\*\* xx indicates that, following the color match process, Heyco adds a two letter suffix to the Root Part No. shown. This suffix will identify your particular CUSTOM Color selection. Consult Heyco for molded nylon color chips for accurate matching. For details as well as information regarding our Stock Colors, see page 6-53.

\*\*\*Consult Heyco for root Part No.

† Max panel thickness is .040" (1,0 mm)

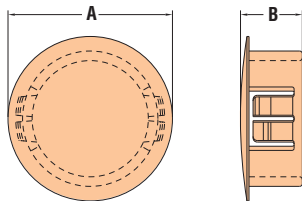

Quick Specs

Material  
Certifications



Nylon 6/6  
Recognized under the Component Program of Underwriters' Laboratories File E51579



Certified by the Canadian Standards Association File 8919

Flammability Rating  
Temperature Range

94V-2  
-40°F (-40°C) to 221°F (105°C)

## Heyco® Large Dome Plugs

Mounting Hole Diameter Range from 3.000" (76,2 mm) to 6.000" (152,4 mm)

Small Packs Available

| MOUNTING HOLE DIAMETER  |       | PART NO. |       | DESCRIPTION | PACKAGING |             | PART DIMENSIONS |               |     |                |     |
|---|-------|----------|-------|-------------|-----------|-------------|-----------------|---------------|-----|----------------|-----|
|   |       | Black    | White |             | BULK      | SMALL PACK* | A               |               | B   |                |     |
| in.   | mm.   |          |       |             |           |             |                 | Head Diameter |     | Overall Height |     |
|   |       |          |       |             |           |             |                 | in.           | mm. | in.            | mm. |
| Multiple Locking Steps for Panel Thickness up to .250" (6,4 mm) |       |          |       |             |           |             |                 |               |     |                |     |
| 3.000   | 76,2  | 2455     | 2456  | DP 3.0      | 300       | 10†         | 3.16            | 80,3          | .74 | 18,8           |     |
| 3.375   | 85,7  | 2482     | 2483  | DP 3.375    | 400       | 5†          | 3.66            | 92,9          | .75 | 19,1           |     |
| 3.500   | 88,9  | 2464     | 2465  | DP 3.5      | 200       | 5†          | 3.66            | 92,9          |     |                |     |
| 4.000   | 101,6 | 2473     | 2474  | DP 4.0      | 300       | 5†          | 4.17            | 105,8         | .71 | 18,0           |     |
| 5.000   | 127,0 | 2451     | 2452  | DP 5.0      | 150       | 1           | 5.24            | 133,0         | .75 | 19,1           |     |
| 6.000   | 152,4 | 2453     | 2454  | DP 6.0      | 130       | 1           | 6.22            | 157,9         | .78 | 19,8           |     |

Standard colors black and white. Consult Heyco for other colors.

\*To order Small Packs, please add the suffix -P to Part No., e.g., 2455-P

† White Small Pack quantity is 1 piece.



## Heyco® Thick Panel Dome Plugs

Mounting Hole Diameter Range: .375" (9,5 mm) to 2.000" (50,8 mm)

| MOUNTING HOLE DIAMETER  |                | PART NO. |       | DESCRIPTION   | PART DIMENSIONS |      |               |      |                |     |  |
|---|----------------|----------|-------|---------------|-----------------|------|---------------|------|----------------|-----|--|
|   |                | Black    | White |               | A               |      | B             |      |                |     |  |
| in.   | mm.            |          |       |               |                 |      | Head Diameter |      | Overall Height |     |  |
|   |                |          |       |               |                 |      | in.           | mm.  | in.            | mm. |  |
| Single Locking Step for Panel Thickness up to .172" (4,4 mm)    |                |          |       |               |                 |      |               |      |                |     |  |
| .375  | 9,5            | 2624     | 2625  | DPT 375       | .47             | 11,9 | .41           | 10,3 |                |     |  |
| Multiple Locking Steps for Panel Thickness up to .250" (6,4 mm) |                |          |       |               |                 |      |               |      |                |     |  |
| .500  | 12,7           | 3004     | 3005  | DPT 500       | .57             | 14,5 | .56           | 14,3 |                |     |  |
| .625  | 15,9           | 3006     | 3007  | DPT 625 *     | .73             | 18,5 | .52           | 13,2 |                |     |  |
| .750  | 19,1           | 3008     | 3009  | DPT 750 *     | .92             | 23,4 |               |      |                |     |  |
| .812  | 19,6           | 2667     | 2668  | DPT 812-500** | 1.02            | 25,9 | .88           | 22,4 |                |     |  |
| .875  | 22,2           | 3044     | 3045  | DPT 875       | 1.02            | 25,9 |               |      |                |     |  |
| 1.000   | 25,4           | 3046     | 3047  | DPT 1000      | 1.20            | 30,5 |               |      |                |     |  |
| 1.093 -<br>1.125  | 27,8 -<br>28,6 | 3018     | 3019  | DPT 1093      | 1.22            | 31,0 |               |      |                |     |  |
| 1.187   | 30,1           | 3100     | 3101  | DPT 1187      | 1.31            | 33,3 | .56           | 14,3 |                |     |  |
| 1.250   | 31,8           | 3102     | 3103  | DPT 1250      | 1.38            | 35,1 |               |      |                |     |  |
| 1.375   | 34,9           | 3106     | 3107  | DPT 1375      | 1.50            | 38,1 |               |      |                |     |  |
| 1.500   | 38,1           | 3048     | 3049  | DPT 1500      | 1.67            | 42,4 |               |      |                |     |  |
| 1.750   | 44,5           | 3027     | 3028  | DPT 1750      | 1.91            | 48,5 |               |      |                |     |  |
| 2.000   | 50,8           | 3050     | 3051  | DPT 2000      | 2.17            | 55,1 | .56           | 14,2 |                |     |  |

Standard color black. Consult Heyco for other colors.

\*Single locking step for panel thickness up to .250" (6,4 mm).

\*\*For Panel Thickness from .20" (5,1 mm) to .50" (12,7 mm). AKA Whistle-free Plug.



- For use in panels thicker than .125" (3,2 mm).
- Close unneeded panel holes and electrical knock-outs.
- Locking fingers snap into holes with fingertip pressure for quick and easy installation.
- Convex, matte finish head tapers to a thin edge.
- Locking fingers in fractional increments up to the maximum panel thickness.
- Withstand a push back force of 35 pounds.
- Available in multiple sizes for use in .375" (9,5 mm) to 2.000" (50,8 mm) diameter holes for panel thickness up to .250" (6,4 mm).
- Approximate Head Thickness: .062" (1,6 mm). Thickness may vary.

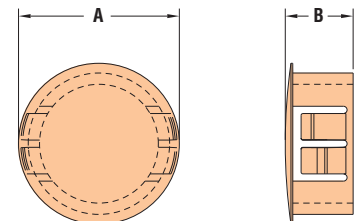

Quick Specs

|                     |   |
|---------------------|---|
| Material            | Nylon 6/6   |
| Certifications      | Recognized under the Component Program of Underwriters' Laboratories, File E51579 (Thick Panel Dome Plugs only)<br>Certified by Canadian Standards Association, File 8919 |
| Flammability Rating | 94V-2   |
| Temperature Range   | -40°F (-40°C) to 221°F (105°C)  |



## Heyco® Shorty Plugs

Single Locking Step for Panel Thickness up to: .062" (1,6 mm)

Mounting Hole Diameter Range: .187" (4,7 mm) to 1.093" (27,8 mm)

- Limited intrusion .125" (3,2 mm) inside the panel.
- Quick and easy installation.
- Multiple sizes for mounting holes from .187" (4,7 mm) to 1.093" (27,8 mm).
- Approximate Head Thickness: .062" (1,6 mm).
- For Shorty Window Plugs see page 6-36.

| MOUNTING HOLE DIAMETER |      | PART NO.    |             |            | DESCRIPTION       | PART DIMENSIONS |                    |     |     |
|------------------------|------|-------------|-------------|------------|-------------------|-----------------|--------------------|-----|-----|
|                        |      | Black       | White       | Colors xx* |                   | A               |                    | B   |     |
| in.                    | mm.  |             |             |            | Head Diameter in. | mm.             | Overall Height in. | mm. |     |
| .187                   | 4,7  | <b>2590</b> | <b>2591</b> | 2592xx     | DP 187†           | .25             | 6,4                | .23 | 5,9 |
| .218                   | 5,5  | <b>1654</b> | <b>1655</b> | 1656xx     | SP 218            | .28             | 7,1                | .25 | 6,4 |
| .281                   | 7,1  | <b>1660</b> | <b>1661</b> | 1662xx     | SP 281            | .34             | 8,7                |     |     |
| <b>NEW!</b> .307       | 7,8  | <b>1657</b> | <b>1658</b> | 1659xx     | SP 307            | .37             | 9,4                |     |     |
| .312                   | 7,9  | <b>1678</b> | <b>1679</b> | 1680xx     | SP 312            | .38             | 9,5                |     |     |
| .343                   | 8,7  | <b>1663</b> | <b>1664</b> | 1665xx     | SP 343            | .41             | 10,3               |     |     |
| .375                   | 9,5  | <b>1681</b> | <b>1682</b> | 1683xx     | SP 375            | .47             | 11,9               |     |     |
| <b>NEW!</b> .390       | 9,9  | <b>1708</b> | <b>1709</b> | 1710xx     | SP 390            |                 |                    |     |     |
| .406                   | 10,3 | <b>1666</b> | <b>1667</b> | 1668xx     | SP 406            |                 |                    |     |     |
| .437                   | 11,1 | <b>1684</b> | <b>1685</b> | 1686xx     | SP 437            | .53             | 13,5               |     |     |
| .468                   | 11,9 | <b>1669</b> | <b>1670</b> | 1671xx     | SP 468            |                 |                    |     |     |
| .500                   | 12,7 | <b>1687</b> | <b>1688</b> | 1689xx     | SP 500            | .56             | 14,3               |     |     |
| .531                   | 13,5 | <b>1672</b> | <b>1673</b> | 1674xx     | SP 531            | .59             | 15,1               |     |     |
| .593                   | 15,1 | <b>1675</b> | <b>1676</b> | 1677xx     | SP 593            | .69             | 17,5               |     |     |
| .625                   | 15,9 | <b>1690</b> | <b>1691</b> | 1692xx     | SP 625            | .72             | 18,3               |     |     |
| <b>NEW!</b> .687       | 17,4 | <b>1719</b> | <b>1720</b> | 1721xx     | SP 687            | .79             | 20,1               |     |     |
| .750                   | 19,0 | <b>1693</b> | <b>1694</b> | 1695xx     | SP 750            | .84             | 21,4               |     |     |
| .781                   | 19,8 | <b>1696</b> | <b>1697</b> | 1698xx     | SP 781            | .89             | 22,6               |     |     |
| .875                   | 22,2 | <b>1699</b> | <b>1700</b> | 1701xx     | SP 875            | .97             | 24,6               |     |     |
| 1.000                  | 25,4 | <b>1702</b> | <b>1703</b> | 1704xx     | SP 1000           | 1.20            | 30,5               |     |     |
| 1.093                  | 27,8 | <b>1705</b> | <b>1706</b> | 1707xx     | SP 1093           | 1.22            | 31,0               |     |     |

Standard colors black or white. Consult Heyco for other colors (see below).

† Convex, glossy finish head.

\*xx indicates that, following the color match process, Heyco adds a two letter suffix to the Root Part No. shown.

This suffix will identify your particular CUSTOM Color selection. Consult Heyco for molded nylon color chips for accurate matching. For details as well as information regarding our Stock Colors, see page 6-53.

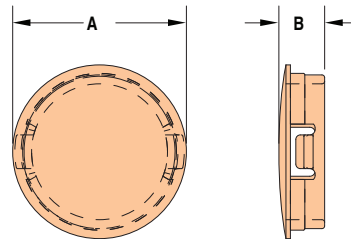

Quick Specs

Material  
Certifications

Nylon 6/6



Recognized under the Component Program of Underwriters' Laboratories File E51579



Certified by the Canadian Standards Association File 8919

Flammability Rating  
Temperature Range

94V-2

-40°F (-40°C) to 221°F (105°C)

“Stay Connected” with



Hole Plugs & Venting Solutions

a PennEngineering® Company



## Heyco® Thin Panel Dome Plugs

Multiple Locking Steps for Panels as Thin as .020" (0,5 mm)  
Mounting Hole Diameter Range: .218" (5,5 mm) to .875" (22,2 mm)\*

| PANEL DIMENSIONS                    |                   |                         |     | PART NO.     |              | DESCRIPTION | PART DIMENSIONS |      |                  |     |
|-------------------------------------|-------------------|-------------------------|-----|--------------|--------------|-------------|-----------------|------|------------------|-----|
| Thickness at Locking Finger Steps   |                   | Mounting Hole Diameter* |     | Black        | White        |             | A Head Diameter |      | B Overall Height |     |
| in.                                 | mm.               | in.                     | mm. |              |              | in.         | mm.             | in.  | mm.              |     |
| Three Steps to .048" (1,2 mm) thick |                   |                         |     |              |              |             |                 |      |                  |     |
| .020<br>.032<br>.048                | 0,5<br>0,8<br>1,2 | .218                    | 5,5 | <b>1654N</b> | <b>1655N</b> | SP 218N     | .28             | 7,1  | .25              | 6,4 |
|                                     |                   | .250                    | 6,4 | <b>2607N</b> | <b>2608N</b> | SP 250N     | .31             | 7,9  |                  |     |
|                                     |                   | .281                    | 7,1 | <b>1660N</b> | <b>1661N</b> | SP 281N     | .34             | 8,7  |                  |     |
|                                     |                   | .312                    | 7,9 | <b>1678N</b> | <b>1679N</b> | SP 312N     | .38             | 9,5  |                  |     |
|                                     |                   | .343                    | 8,7 | <b>1663N</b> | <b>1664N</b> | SP 343N     | .41             | 10,3 |                  |     |
|                                     |                   | .375                    | 9,5 | <b>1681N</b> | <b>1682N</b> | SP 375N     | .47             | 11,9 |                  |     |

|                                      |                                 |      |      |              |              |         |     |      |     |     |
|--------------------------------------|---------------------------------|------|------|--------------|--------------|---------|-----|------|-----|-----|
| Five Steps to .064" (1,6 mm) thick   |                                 |      |      |              |              |         |     |      |     |     |
| .020<br>.032<br>.040<br>.048<br>.064 | 0,5<br>0,8<br>1,0<br>1,2<br>1,6 | .500 | 12,7 | <b>1687N</b> | <b>1688N</b> | SP 500N | .56 | 14,3 | .25 | 6,4 |
|                                      |                                 | .512 | 13,0 | <b>1716N</b> | <b>1717N</b> | SP 512N |     |      |     |     |
|                                      |                                 | .625 | 15,9 | <b>1690N</b> | <b>1691N</b> | SP 625N |     |      |     |     |
|                                      |                                 | .750 | 19,1 | <b>1693N</b> | <b>1694N</b> | SP 750N |     |      |     |     |
|                                      |                                 | .875 | 22,2 | <b>1699N</b> | <b>1700N</b> | SP 875N |     |      |     |     |
|                                      |                                 | .97  | 24,6 |              |              |         |     |      |     |     |

Standard color black. Consult Heyco for other colors.

\*Consult Heyco for other Mounting Hole Diameters. Our Axcell Rapid Response Team is ready to meet your requirements.

- Provide a flush, finished fit in panels as thin as .020" (0,5 mm).
- Quick and easy installation.
- Multiple sizes for mounting holes from .218" (5,5 mm) to .875" (22,2 mm).
- Consult Heyco for other Thin Panel Mounting Hole Diameters.
- Lock firmly in panels up to .064" (1,6 mm) thick.

**NEW!**

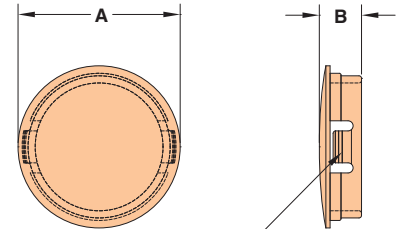

MULTIPLE FINGER STEPS FOR TIGHT PANEL FIT

## Heyco® Thin Panel versus Shorty Plugs

Choose from Multiple Locking Steps, for the Fit and Finish Your Application Requires

| Mounting Hole Diameter | PANEL DIMENSIONS                |             |             |             |             | PART NO.    |              | DESCRIPTION  |         |
|------------------------|---------------------------------|-------------|-------------|-------------|-------------|-------------|--------------|--------------|---------|
|                        | Maximum Thickness Locking Steps |             |             |             |             | Black       | White        |              |         |
|                        | inches/millimeters              |             |             |             |             |             |              |              |         |
| in.                    | mm.                             | .020<br>0,5 | .032<br>0,8 | .040<br>1,0 | .048<br>1,2 | .064<br>1,6 |              |              |         |
| .218                   | 5,5                             | x           | x           |             | x           |             | <b>1654N</b> | <b>1655N</b> | SP 218N |
|                        |                                 |             |             |             |             | x           | <b>1654</b>  | <b>1655</b>  | SP 218  |
| .250                   | 6,4                             | x           | x           |             | x           |             | <b>2607N</b> | <b>2608N</b> | SP 250N |
| .281                   | 7,1                             | x           | x           |             | x           |             | <b>1660N</b> | <b>1661N</b> | SP 281N |
|                        |                                 |             |             |             |             | x           | <b>1660</b>  | <b>1661</b>  | SP 281  |
| .312                   | 7,9                             | x           | x           |             | x           |             | <b>1678N</b> | <b>1679N</b> | SP 312N |
|                        |                                 |             |             |             |             | x           | <b>1678</b>  | <b>1679</b>  | SP 312  |
| .343                   | 8,7                             | x           | x           |             | x           |             | <b>1663N</b> | <b>1664N</b> | SP 343N |
|                        |                                 |             |             |             |             | x           | <b>1663</b>  | <b>1664</b>  | SP 343  |
| .375                   | 9,5                             | x           | x           |             | x           |             | <b>1681N</b> | <b>1682N</b> | SP 375N |
|                        |                                 |             |             |             |             | x           | <b>1681</b>  | <b>1682</b>  | SP 375  |
| .500                   | 12,7                            | x           | x           | x           | x           | x           | <b>1687N</b> | <b>1688N</b> | SP 500N |
|                        |                                 |             |             |             |             | x           | <b>1687</b>  | <b>1688</b>  | SP 500  |
| .625                   | 12,7                            | x           | x           | x           | x           | x           | <b>1690N</b> | <b>1691N</b> | SP 625N |
|                        |                                 |             |             |             |             | x           | <b>1690</b>  | <b>1691</b>  | SP 625  |
| .750                   | 19,1                            | x           | x           | x           | x           | x           | <b>1693N</b> | <b>1694N</b> | SP 750N |
|                        |                                 |             |             |             |             | x           | <b>1693</b>  | <b>1694</b>  | SP 750  |
| .875                   | 22,2                            | x           | x           | x           | x           | x           | <b>1699N</b> | <b>1700N</b> | SP 875N |
|                        |                                 |             |             |             |             | x           | <b>1699</b>  | <b>1700</b>  | SP 875  |

Material Certifications



Nylon 6/6  
Recognized under the Component Program of Underwriters' Laboratories, File E51579



Certified by Canadian Standards Association, File 8919

Flammability Rating  
Temperature Range

94V-2  
-40°F (-40°C) to 221°F (105°C)

Quick Specs

"Stay Connected" with



Hole Plugs & Venting Solutions

a PennEngineering® Company



- **Molded from a nylon material which, in the event of a fire, will not burn and will not produce toxic gases.** Also formulated for sunlight resistance. Other Heyco products are available in this material—please consult Heyco.
- Close unneeded panel holes.
- Quick and easy installation.
- Convex, matte finish head tapers to a thin edge (Except HFP-187 glossy finish).
- Lock firmly into panel up to .125" (3,2 mm) thick.
- Locking fingers in fractional increments up to the maximum panel thickness.
- Approximate Head Thickness: .062" (1,6 mm). Thickness may vary.
- Multiple sizes for use in .187" (4,7 mm) to 2.000" (50,8 mm) diameter holes. Consult Heyco for larger sizes.

## Heyco® Halogen and Phosphorus-Free 94V-0 Hole Plugs

Heat Stabilized • Self Extinguishing • Nontoxic • UV Resistant

Mounting Hole Diameter Range: .187" (4,7 mm) to 2.000" (50,8 mm)

| MOUNTING HOLE DIAMETER |     | PART NO. | DESCRIPTION | PART DIMENSIONS |                    |     |                     |
|------------------------|-----|----------|-------------|-----------------|--------------------|-----|---------------------|
| in.                    | mm. |          |             | Black           | A<br>Head Diameter |     | B<br>Overall Height |
|                        |     |          |             | in.             | mm.                | in. | mm.                 |

Single Locking Step for Panel Thickness up to .062" (1,6 mm)

|      |     |             |          |     |     |     |     |
|------|-----|-------------|----------|-----|-----|-----|-----|
| .187 | 4,7 | <b>2593</b> | HFP 187* | .25 | 6,4 | .24 | 6,1 |
| .250 | 6,4 | <b>2606</b> | HFP 250  | .31 | 7,9 | .31 | 7,9 |
| .312 | 7,9 | <b>2616</b> | HFP 312  | .38 | 9,5 |     |     |

Multiple Locking Steps for Panel Thickness up to .125" (3,2 mm)

|               |             |             |          |      |      |     |      |
|---------------|-------------|-------------|----------|------|------|-----|------|
| .375          | 9,5         | <b>2623</b> | HFP 375  | .47  | 11,9 | .41 | 10,3 |
| .437          | 11,1        | <b>2636</b> | HFP 437  | .53  | 13,5 |     |      |
| .500          | 12,7        | <b>2646</b> | HFP 500  | .58  | 14,7 |     |      |
| .625          | 15,9        | <b>2666</b> | HFP 625  | .72  | 18,2 |     |      |
| .750          | 19,1        | <b>2686</b> | HFP 750  | .92  | 23,4 | .45 | 11,5 |
| .875          | 22,2        | <b>2706</b> | HFP 875  | 1.02 | 25,8 |     |      |
| 1.000         | 25,4        | <b>2716</b> | HFP 1000 | 1.20 | 30,6 |     |      |
| 1.093 - 1.125 | 27,8 - 28,6 | <b>2729</b> | HFP 1093 | 1.22 | 30,9 |     |      |
| 1.250         | 31,7        | <b>2749</b> | HFP 1250 | 1.38 | 34,9 | .47 | 11,9 |
| 1.375         | 34,9        | <b>2759</b> | HFP 1375 | 1.50 | 38,1 |     |      |
| 1.500         | 38,1        | <b>2769</b> | HFP 1500 | 1.69 | 42,8 |     |      |
| 1.750         | 44,5        | <b>2779</b> | HFP 1750 | 1.92 | 48,7 |     |      |
| 2.000         | 50,8        | <b>2789</b> | HFP 2000 | 2.17 | 55,1 |     |      |

Multiple Locking Steps for Panel Thickness up to .250" (6,4 mm)

**ALL NEW PRODUCTS**

|             |           |              |            |      |      |     |      |
|-------------|-----------|--------------|------------|------|------|-----|------|
| .500        | 12,7      | <b>3004F</b> | HFPT 500   | .58  | 14,7 | .56 | 14,3 |
| .625        | 15,9      | <b>3006F</b> | HFPT 625 * | .73  | 18,5 | .52 | 13,2 |
| .750        | 19,1      | <b>3008F</b> | HFPT 750 * | .91  | 23,1 | .56 | 14,3 |
| .875        | 22,2      | <b>3044F</b> | HFPT 875   | 1.02 | 25,8 |     |      |
| 1.000       | 25,4      | <b>3046F</b> | HFPT 1000  | 1.20 | 30,6 |     |      |
| 1.093-1.125 | 27,8-28,6 | <b>3018F</b> | HFPT 1093  | 1.22 | 30,9 |     |      |
| 1.250       | 31,7      | <b>3102F</b> | HFPT 1250  | 1.38 | 34,9 | .58 | 14,7 |
| 1.375       | 34,9      | <b>3106F</b> | HFPT 1375  | 1.50 | 38,1 |     |      |
| 1.500       | 38,1      | <b>3048F</b> | HFPT 1500  | 1.67 | 42,4 |     |      |
| 1.750       | 44,5      | <b>3027F</b> | HFPT 1750  | 1.91 | 48,4 |     |      |
| 2.000       | 50,8      | <b>3050F</b> | HFPT 2000  | 2.17 | 55,1 |     |      |

Standard color black.  
\*Convex, glossy finish head.

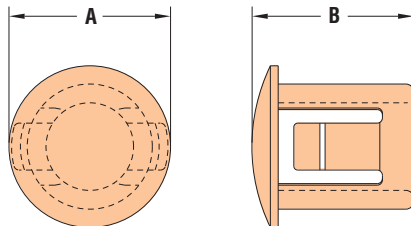

SINGLE PANEL THICKNESS DESIGN

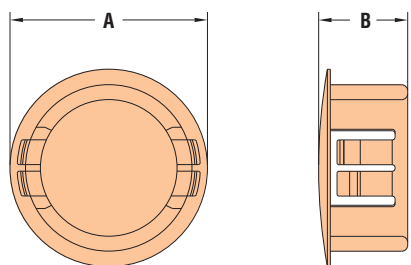

MULTIPLE PANEL THICKNESS DESIGN

*Quick Specs*

Material  
Certifications

Nylon 6/6



Recognized under the Component Program of Underwriters' Laboratories File E51579



Certified by the Canadian Standards Association File 8919

Flammability Rating  
Temperature Range

94V-0

-40°F (-40°C) to 221°F (105°C)



“Stay Connected” with



Hole Plugs & Venting Solutions

a PennEngineering® Company



## Heyco® Extra Dome Plugs

Multiple Locking Steps for Panel Thickness up to .250" (6,4 mm)

| MOUNTING HOLE DIAMETER |       | PART NO. |       | DESCRIPTION | PART DIMENSIONS |       |                  |      |                 |      |
|------------------------|-------|----------|-------|-------------|-----------------|-------|------------------|------|-----------------|------|
|                        |       | Black    | White |             | A Head Diameter |       | B Overall Height |      | C Inside Height |      |
| in.                    | mm.   |          |       |             | in.             | mm.   | in.              | mm.  | in.             | mm.  |
| 3.0                    | 76,2  | 2442     | 2443  | EDP 3.0     | 3.22            | 81,8  | 1.37             | 34,8 | 1.26            | 32,0 |
| 5.0                    | 127,0 | 2444     | 2445  | EDP 5.0     | 5.22            | 132,6 | 1.41             | 35,8 | 1.31            | 33,3 |

Standard colors black. Consult Heyco for other colors.

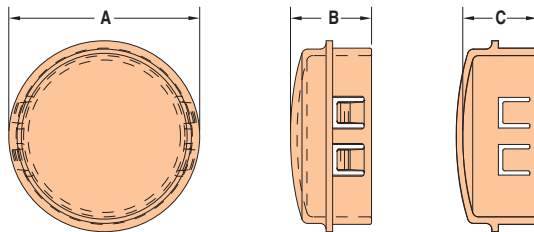

- Extra dome height for additional clearance under the top.
- Consult Heyco for additional sizes.
- Lock firmly into panels up to .250" (6,4 mm) thick.
- Locking fingers in fractional increments up to the maximum panel thickness.
- Not UL Recognized.



## Heyco® Snap-In Metric Dome Plugs

Multiple Locking Steps for Panel Thickness up to 4,1 mm (.162")

Mounting Hole Diameter Range: 13,0 mm (.512") to 34,2 mm (1.347")

|             | MOUNTING HOLE DIAMETER |       | PART NO. |       | DESCRIPTION | PART DIMENSIONS |      |                  |      |
|-------------|------------------------|-------|----------|-------|-------------|-----------------|------|------------------|------|
|             | mm.                    | in.   | Black    | White |             | A Head Diameter |      | B Overall Height |      |
|             |                        |       |          |       |             | mm.             | in.  | mm.              | in.  |
| <b>NEW!</b> | 13,0                   | .512  | 2203     | 2204  | MDP 13      | 14,2            | .56  |                  |      |
|             | 16,0                   | .630  | 2128     | 2130  | MDP 16      | 18,5            | .73  | 10,3             | .406 |
|             | 20,0                   | .787  | 2131     | 2132  | MDP 20      | 22,6            | .89  |                  |      |
| <b>NEW!</b> | 22,0                   | .866  | 2205     | 2206  | MDP 22      | 25,9            | 1.02 |                  |      |
|             | 25,0                   | .984  | 2133     | 2134  | MDP 25      | 29,8            | 1.17 |                  |      |
| <b>NEW!</b> | 28,0                   | 1.102 | 2215     | 2216  | MDP 28      | 31,2            | 1.23 | 11,5             | .453 |
|             | 32,0                   | 1.260 | 2135     | 2136  | MDP 32      | 35,3            | 1.38 |                  |      |
| <b>NEW!</b> | 34,2                   | 1.347 | 2218     | 2219  | MDP 34      | 38,1            | 1.50 |                  |      |

Standard color black. Consult Heyco for other colors.

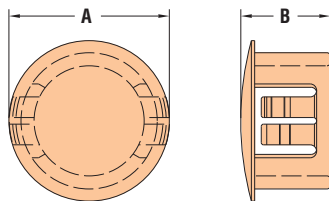

- Multiple sizes for use in **13,0 mm (.512") to 34,2 mm (1.347") diameter holes**. For other metric sizes, consult Heyco.
- Close unneeded panel holes.
- Quick and easy installation.
- Convex, matte finish head tapers to a thin edge.
- Lock firmly into panel up to 4,1 mm (.162") thick.
- Approximate Head Thickness: 1,6 mm (.062").
- For **Threaded Metric Plugs**, see page 6-44.
- For our complete range of Dome Plugs, see pages 6-25 and 6-26.

Material Certifications



Nylon 6/6  
Recognized under the Component Program of Underwriters' Laboratories, File E51579 (MDP's only)



Certified by Canadian Standards Association, File 8919 (MDP's only)

Flammability Rating  
Temperature Range

94V-2  
-40°F (-40°C) to 221°F (105°C)

Quick Specs

“Stay Connected” with



Hole Plugs & Venting Solutions

a PennEngineering® Company



- **Smooth, glossy head** provides easy glide and shiny finish.
- Close unneeded panel openings.
- Locking fingers snap into holes with fingertip pressure for quick and easy installation.
- Locking fingers in fractional increments up to the maximum panel thickness.
- Multiple sizes for use in .187" (4,7 mm) to 2.000" (50,8 mm) diameter holes.
- Lock firmly in panel up to .125" (3,2 mm) thick. (G parts)
- For use in panels thicker than .125" (3,2 mm). (GPT parts)
- Withstand a push back force of 35 pounds.

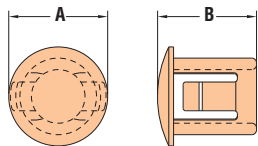

SINGLE PANEL THICKNESS DESIGN

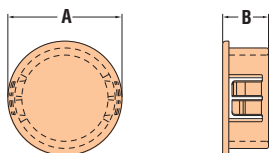

MULTIPLE PANEL THICKNESS DESIGN

## Heyco® Glossy and Thick Panel Glossy Plugs

Mounting Hole Diameter Range: .187" (4,7 mm) to 2.000" (50,8 mm)

| MOUNTING HOLE DIAMETER<br>in.   mm.                             | PART NO.    |       | DESCRIPTION | PART DIMENSIONS                 |      |                                  |     |      |     |      |
|---|-------------|-------|-------------|---------------------------------|------|----------------------------------|-----|------|-----|------|
|   | Black       | White |             | A<br>Head Diameter<br>in.   mm. |      | B<br>Overall Height<br>in.   mm. |     |      |     |      |
| Single Locking Step for Panel Thickness up to .062" (1,6 mm)    |             |       |             |                                 |      |                                  |     |      |     |      |
| .187  | 4,7         | 2590  | 2591        | DP 187*                         | .25  | 6,4                              | .23 | 5,9  |     |      |
| .250  | 6,4         | 2600  | 2601        | G 250                           | .31  | 7,9                              | .31 | 7,9  |     |      |
| .312  | 7,9         | 2610  | 2611        | G 312                           | .38  | 9,5                              |     |      |     |      |
| Multiple Locking Steps for Panel Thickness up to .125" (3,2 mm) |             |       |             |                                 |      |                                  |     |      |     |      |
| .375  | 9,5         | 2620  | 2621        | G 375                           | .47  | 11,9                             | .41 | 10,3 |     |      |
| .437  | 11,1        | 2630  | 2631        | G 437                           | .53  | 13,5                             |     |      |     |      |
| .500  | 12,7        | 2640  | 2641        | G 500                           | .56  | 14,3                             |     |      |     |      |
| .562  | 14,3        | 2650  | 2651        | G 562                           | .66  | 16,7                             |     |      |     |      |
| .625  | 15,9        | 2660  | 2661        | G 625                           | .73  | 18,6                             |     |      |     |      |
| .750  | 19,1        | 2680  | 2681        | G 750                           | .86  | 21,8                             |     |      |     |      |
| .875  | 22,2        | 2700  | 2701        | G 875                           | .95  | 24,2                             | .45 | 11,5 |     |      |
| 1.000   | 25,4        | 2710  | 2711        | G 1000                          | 1.13 | 28,6                             |     |      |     |      |
| 1.093 - 1.125   | 27,8 - 28,6 | 2720  | 2721        | G 1093                          | 1.22 | 30,9                             |     |      |     |      |
| 1.187   | 30,1        | 2730  | 2731        | G 1187                          | 1.31 | 33,3                             |     |      |     |      |
| 1.375   | 34,9        | 2760  | 2761        | G 1375                          | 1.49 | 37,7                             |     |      |     |      |
| 1.500   | 38,1        | 2770  | 2771        | G 1500                          | 1.61 | 40,8                             |     |      |     |      |
| 1.750   | 44,4        | 2780  | 2781        | G 1750                          | 1.88 | 47,6                             |     |      |     |      |
| 2.000   | 50,8        | 2795  | 2796        | G 2000                          | 2.13 | 54,8                             |     |      |     |      |
| Multiple Locking Steps for Panel Thickness up to .250" (6,4 mm) |             |       |             |                                 |      |                                  |     |      |     |      |
| .500  | 12,7        | 2430  | 2431        | GPT 500                         | .56  | 14,3                             |     |      | .56 | 14,3 |
| .625  | 15,9        | 3134  | 3135        | GPT 625**                       | .72  | 18,3                             | .52 | 13,1 |     |      |
| .750  | 19,1        | 3136  | 3137        | GPT 750**                       | .85  | 21,6                             |     |      |     |      |
| .875  | 22,2        | 3138  | 3139        | GPT 875                         | .95  | 24,2                             | .56 | 14,3 |     |      |
| 1.000   | 25,4        | 3140  | 3141        | GPT 1000                        | 1.13 | 28,6                             |     |      |     |      |
| 1.093 - 1.125   | 27,8 - 28,6 | 3142  | 3143        | GPT 1093                        | 1.22 | 30,9                             |     |      |     |      |
| 1.187   | 30,1        | 3144  | 3145        | GPT 1187                        | 1.31 | 33,3                             |     |      |     |      |
| 1.375   | 34,9        | 2432  | 2433        | GPT 1375                        | 1.49 | 37,7                             |     |      |     |      |
| 1.500   | 38,1        | 2428  | 2429        | GPT 1500                        | 1.61 | 40,8                             |     |      |     |      |
| 1.750   | 44,4        | 2436  | 2437        | GPT 1750                        | 1.88 | 47,6                             |     |      |     |      |
| 2.000   | 50,8        | 2438  | 2439        | GPT 2000                        | 2.16 | 54,8                             |     |      |     |      |

Standard color black. Consult Heyco for other colors.

\*Convex, glossy finished head tapers to a thin edge.

\*\* Single locking steps for Panel Thickness up to .250" (6,4 mm)

Quick Specs

Material Certifications



Nylon 6/6  
Recognized under the Component Program of Underwriters' Laboratories, File E51579



Certified by Canadian Standards Association, File 8919

Flammability Rating  
Temperature Range

94V-2  
-40°F (-40°C) to 221°F (105°C)

## Heyco® Pry Out Plugs

### Standard Finger Design

Mounting Hole Diameter Range: .250" (6,4 mm) to 2.500" (63,5 mm)

| MOUNTING HOLE DIAMETER                                 |      | PART NO. |       | DESCRIPTION | PART DIMENSIONS    |      |                     |      |
|--|------|----------|-------|-------------|--------------------|------|---------------------|------|
| in.  | mm.  | Black    | White |             | A<br>Head Diameter |      | B<br>Overall Height |      |
| Clearance Fit for Panel Thickness up to .156" (4,0 mm) |      |          |       |             |                    |      |                     |      |
| .250   | 6,4  | 3053     | 3054  | POP 250     | .42                | 10,7 | .33                 | 8,3  |
| Clearance Fit for Panel Thickness up to .172" (4,4 mm) |      |          |       |             |                    |      |                     |      |
| .312   | 7,9  | 3056     | 3057  | POP 312     | .51                | 12,9 | .41                 | 10,4 |
| .375   | 9,5  | 3059     | 3060  | POP 375     | .58                | 14,7 |                     |      |
| .437   | 11,1 | 3062     | 3063  | POP 437     | .61                | 15,5 |                     |      |
| .500   | 12,7 | 3065     | 3066  | POP 500     | .67                | 17,0 |                     |      |
| .562   | 14,3 | 3068     | 3069  | POP 562     | .73                | 18,6 |                     |      |
| .625   | 15,9 | 3071     | 3072  | POP 625     | .80                | 20,2 |                     |      |
| .687   | 17,4 | 3074     | 3075  | POP 687     | .89                | 22,6 |                     |      |
| .750   | 19,0 | 3077     | 3078  | POP 750     | .97                | 24,6 |                     |      |
| .812   | 20,6 | 3080     | 3081  | POP 812     | 1.03               | 26,2 |                     |      |
| .875   | 22,2 | 3083     | 3084  | POP 875     | 1.08               | 27,4 |                     |      |
| 1.000  | 25,4 | 3086     | 3087  | POP 1000    | 1.22               | 30,9 |                     |      |
| 1.093  | 27,8 | 3089     | 3090  | POP 1093    | 1.30               | 32,9 |                     |      |
| 1.187  | 30,1 | 3092     | 3093  | POP 1187    | 1.41               | 35,7 |                     |      |
| 1.250  | 31,8 | 3095     | 3096  | POP 1250    | 1.45               | 36,9 |                     |      |
| 1.375  | 34,9 | 3098     | 3099  | POP 1375    | 1.58               | 40,1 | .45                 | 11,5 |
| Clearance Fit for Panel Thickness up to .250" (6,4 mm) |      |          |       |             |                    |      |                     |      |
| 1.500  | 38,1 | 3124     | 3125  | POP 1500    | 1.72               | 43,6 | .45                 | 11,5 |
| 1.750  | 44,5 | 2973     | 2974  | POP 1750    | 1.98               | 50,3 | .48                 | 12,2 |
| 2.000  | 50,8 | 2798     | 2799  | POP 2000    | 2.22               | 56,4 | .48                 | 12,2 |
| 2.500  | 63,5 | 2975     | 2976  | POP 2.5     | 2.69               | 68,4 | .74                 | 18,8 |

Standard color black. Consult Heyco for other colors.

### Prong Finger Design

Mounting Hole Diameter Range: .187" (4,7 mm) to .375" (9,5 mm)

| WILL FIT THESE PANELS                          |         |         |         |                 |         |         |         | PART NO. |         | DESCRIPTION | HEAD STYLE | PART DIMENSIONS    |      |                     |      |
|--|---------|---------|---------|-----------------|---------|---------|---------|----------|---------|-------------|------------|--------------------|------|---------------------|------|
| MOUNTING HOLE DIAMETER                         |         |         |         | THICKNESS RANGE |         |         |         | Black    | Natural |             |            | A<br>Head Diameter |      | B<br>Overall Height |      |
| Minimum  | Maximum | Minimum | Maximum | Minimum         | Maximum | Minimum | Maximum |          |         | in.         | mm.        | in.                | mm.  |                     |      |
| Clearance Fit for Panel Thickness Ranges Shown |         |         |         |                 |         |         |         |          |         |             |            |                    |      |                     |      |
| .187   | 4,7     | .192    | 4,9     | .031            | 0,8     | .062    | 1,6     | 12170    | 12171   | PPL 187     | Glossy     | .35                | 8,9  | .18                 | 4,6  |
| .313   | 8,0     | .318    | 8,1     | .047            | 1,2     | .156    | 4,0     | 12178    | 12179   | PPL 313     | Dome       | .58                | 14,7 | .41                 | 10,4 |
| .375   | 9,5     | .380    | 9,7     | .093            | 2,4     | .312    | 7,9     | 12182    | 12183   | PPL 375     | Glossy     | .19                | 12,4 | .53                 | 13,5 |

Standard color black and natural.

|                     |   |
|---------------------|---|
| Material            | Nylon 6/6   |
| Certifications      | Recognized under the Component Program of Underwriters' Laboratories, File E51579 (POP Plugs only)<br>Certified by the Canadian Standards Association, File 8919 (POP Plugs only) |
| Flammability Rating | 94V-2   |
| Temperature Range   | -40°F (-40°C) to 221°F (105°C) (POP Plugs only)<br>32°F (0°C) to 185°F (85°C) (PPL Plugs only)  |



- POP in closures for pipe and tubing ends.
- Retaining fingers without locking steps provide friction fit and allow removal of plug.
- Bumper protection.
- Flat, matte finish head.
- Multiple sizes for use in .250" (6,4 mm) to 2.500" (63,5 mm) diameter holes for panel thickness up to .250" (6,4 mm).
- Approximate Head Thickness: .062" (1,6 mm).

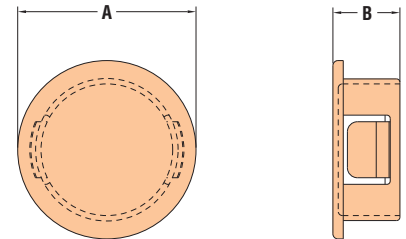

- Flexible and tapered prongs on plug will snugly lock in place with fingertip pressure, but can be removed & reused.
- Durable and non-conductive.
- Excellent dust protection for electronic equipment.
- Abrasion and vibration resistant.
- May be used as temporary or permanent hole plugs.
- Function as feet on small appliances.
- May be used to close tube ends.

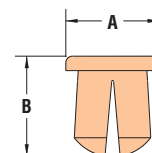



- Close unneeded sheet metal panel holes, *ergonomically*.
- Flush button head style.
- Quick, easy installation; quick, easy removal, too.
- Heyco Metric Ergonomic Plugs offer greater versatility because their pliable nature allows one plug size to fit a variety of different sized holes.
- UV resistant material allows plugs to be suitable for outdoor exposure (sunlight resistant).
- Available in multiple sizes from 14,5 mm (.57") through 34,0 mm (1.34") diameter holes.

## Heyco® Metric Ergonomic Plugs

For Panel Thickness from 0,8 mm (.03") to 2,0 mm (.08")  
 Mounting Hole Diameter Range: 14,5 mm (.57") to 34,0 mm (1.34")

| MOUNTING HOLE DIAMETER |                |             | PART NO.    | DESCRIPTION   | PART DIMENSIONS |      |                 |      |     |                |     |     |
|------------------------|----------------|-------------|-------------|---------------|-----------------|------|-----------------|------|-----|----------------|-----|-----|
| NOMINAL                | DIAMETER RANGE |             |             |               | A               | B    |                 | C    |     |                |     |     |
| mm.                    | mm.            | in.         | Black       | Head Diameter | mm.             | in.  | Bottom Diameter | mm.  | in. | Overall Height | mm. | in. |
| 15                     | 14,5 - 16,0    | .57 - .63   | <b>9690</b> | SMP E-M15     | 25,0            | .98  | 18,0            | .71  | 7,8 | .31            |     |     |
| 17                     | 15,2 - 18,0    | .65 - .71   | <b>9691</b> | SMP E-M17     | 28,0            | 1.10 | 20,3            | .80  |     |                |     |     |
| 19                     | 18,5 - 20,0    | .73 - .79   | <b>9692</b> | SMP E-M19     | 30,2            | 1.19 | 22,5            | .89  |     |                |     |     |
| 21                     | 20,5 - 22,0    | .81 - .87   | <b>9693</b> | SMP E-M21     | 32,0            | 1.26 | 24,3            | .96  |     |                |     |     |
| 23                     | 22,5 - 24,0    | .87 - .95   | <b>9694</b> | SMP E-M23     | 34,0            | 1.34 | 26,4            | 1.04 |     |                |     |     |
| 25                     | 24,5 - 26,0    | .97 - 1.02  | <b>9695</b> | SMP E-M25     | 35,0            | 1.38 | 28,0            | 1.10 |     |                |     |     |
| 27                     | 26,5 - 28,0    | 1.04 - 1.10 | <b>9696</b> | SMP E-M27     | 38,0            | 1.50 | 30,3            | 1.19 |     |                |     |     |
| 29                     | 28,5 - 30,0    | 1.12 - 1.18 | <b>9697</b> | SMP E-M29     | 40,0            | 1.58 | 32,3            | 1.27 |     |                |     |     |
| 31                     | 30,5 - 32,0    | 1.20 - 1.26 | <b>9698</b> | SMP E-M31     | 42,0            | 1.65 | 34,3            | 1.35 |     |                |     |     |
| 33                     | 32,5 - 34,0    | 1.28 - 1.34 | <b>9699</b> | SMP E-M33     | 44,0            | 1.73 | 36,3            | 1.43 |     |                |     |     |

Standard color black.

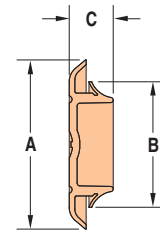
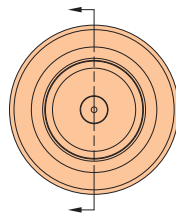

- Closes cavity-fill insulation holes in wood and other type siding.
- Fills holes in surfaces of unspecified thickness including cabinetry, furniture, display cases—even masonry.
- Convex, matte finish head blends with various surfaces.
- Quick and easy installation with fingertip pressure (no tool required).
- Holds securely in hole.

## Heyco® Insulation Plug

No Maximum Panel Thickness

| MOUNTING HOLE DIAMETER |      | PART NO.    |             | DESCRIPTION | PART DIMENSIONS |                |     |      |
|------------------------|------|-------------|-------------|-------------|-----------------|----------------|-----|------|
| in.                    | mm.  | Black       | White       |             | A               | B              |     |      |
|                        |      |             |             |             | Head Diameter   | Overall Height | in. | mm.  |
| 1.000                  | 25,4 | <b>3149</b> | <b>3150</b> | IPW 1       | 1.23            | 31,3           | .69 | 17,5 |

Standard color black. Consult Heyco for other colors.

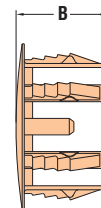
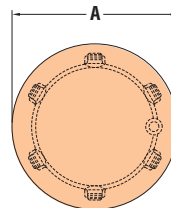

Quick  
Specs

|                     |  |
|---------------------|--|
| Material            | SMP E Flex Temp (Thermoplastic Rubber) |
| Material            | IPW Nylon 6/6                          |
| Flammability Rating | 94V-2                                  |
| Temperature Range   | (Both) -40°F (-40°C) to 221°F (105°C)  |

“Stay Connected” with



Hole Plugs & Venting Solutions

a PennEngineering® Company



## Heyco® Double D Hole Plugs

For Mounting Holes with Flats

Multiple Locking Steps for Panel Thickness up to .125" (3,2 mm)

| PANEL DIMENSIONS   |                     |                    |                     | PART NO. |       | DESCRIPTION    | PART DIMENSIONS |      |     |      |
|--------------------|---------------------|--------------------|---------------------|----------|-------|----------------|-----------------|------|-----|------|
| D                  |                     | C                  |                     | Black    | White |                | A               |      | B   |      |
| Mounting Hole Dia. | To Prevent Rotation | Mounting Hole Dia. | To Prevent Rotation |          |       | Head Diameter  | Overall Height  | in.  | mm. | in.  |
| .375               | 9,5                 | .345               | 8,8                 | 2617     | 2618  | DP 375*        | .47             | 11,9 | .41 | 10,3 |
| .437               | 11,1                | .390               | 9,9                 | 2488     | 2489  | DD 437-390     | .53             | 13,5 |     |      |
| .500               | 12,7                | .445               | 11,3                | 2491     | 2492  | DD 500-445     | .55             | 14,7 |     |      |
| .562               | 14,3                | .530               | 13,5                | 2494     | 2495  | DD 562-530     | .66             | 16,7 |     |      |
| .625               | 15,9                | .550               | 14,0                | 2497     | 2498  | DD 625-550     | .73             | 18,5 |     |      |
| .750               | 19,1                | .625               | 15,9                | 2503     | 2504  | DD 750-625     | .92             | 23,4 |     |      |
| .875               | 22,2                | .770               | 19,5                | 2509     | 2510  | DD 875-770     | 1.02            | 25,8 | .45 | 11,5 |
|                    |                     |                    |                     | 2511     | -     | DD 875-770-9** | .94             | 23,8 |     |      |
| 1.109              | 28,2                | 1.000              | 25,4                | 2717     | 2718  | DD 1109-1000   | 1.22            | 30,9 |     |      |
| 2.000              | 50,8                | 1.875              | 47,6                | 2959     | 2963  | DD 2000-1875   | 2.17            | 55,1 | .48 | 12,1 |

Standard colors black and white. Consult Heyco for other colors.

\*On installation, DP 375 Locking Fingers must be aligned with Mounting Hole Flats.

\*\*Smaller than standard Head Diameter, for clearance situations.

- Close unwanted Strain Relief mounting holes or other double faced or Double D holes punched or molded with two opposing flats.
- Convex, matte finish head tapers to a thin edge.
- Quick and easy installation.
- Lock firmly in panels up to .125" (3,2 mm) thick.
- Locking fingers in fractional increments up to the maximum panel thickness.
- Approximate Head Thickness: .062" (1,6 mm). Thickness may vary.

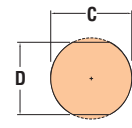
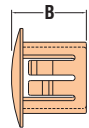
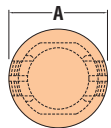

MOUNTING HOLE

DD Series

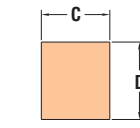
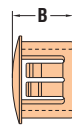
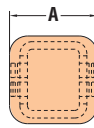

MOUNTING HOLE

RP Series

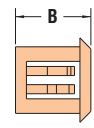
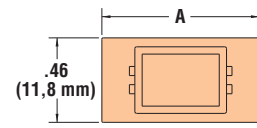

3299, 3388, 3389

## Heyco® Rectangular Blanking & Connector Port Plugs

Multiple Locking Steps for Various Panel Thicknesses

| Maximum Thickness          | PANEL DIMENSIONS |        |       |      | PART NO. | DESCRIPTION     | PART DIMENSIONS |             |             |     |      |
|----------------------------|------------------|--------|-------|------|----------|-----------------|-----------------|-------------|-------------|-----|------|
|                            | C                |        | D     |      |          |                 | A               |             | B           |     |      |
| in.                        | mm.              | Length | Width | in.  | mm.      | Head Dimensions | Overall Height  | in.         | mm.         |     |      |
| Rectangular Blanking Plugs |                  |        |       |      |          |                 |                 |             |             |     |      |
| .03                        | 0,64             | .96    | 24,5  | .96  | 24,5     | 13910           | RP 245-245      | 1.06 x 1.06 | 26,9 x 26,9 | .30 | 7,6  |
|                            |                  |        |       |      |          | 13911           | RB 245-245*     | 1.05 x 1.05 | 26,7 x 26,7 |     |      |
| .04                        | 1,0              | .27    | 6,9   | .29  | 7,4      | 2512            | RP 69-74        | .37 x .37   | 9,4 x 9,4   | .33 | 8,4  |
| .10                        | 2,5              | .45    | 11,5  | .51  | 13,9     | 1890            | RP 115-130      | .58 x .58   | 14,7 x 14,7 | .40 | 10,2 |
| .13                        | 3,2              | .94    | 23,8  | 1.65 | 42,0     | 2513            | RP 239-419      | 2.17 x 1.38 | 55,1 x 35,0 | .46 | 11,7 |
| .16                        | 4,0              | .69    | 17,5  | .69  | 17,5     | 1892            | RP 175-175      | .83 x .83   | 21,1 x 21,1 | .47 | 11,9 |
| Connector Port Plugs       |                  |        |       |      |          |                 |                 |             |             |     |      |
| .14                        | 3,5              | .37    | 9,5   | .51  | 13,0     | 3299            | RP 95-130-1     | .63         | 16,0        | .41 | 10,5 |
|                            |                  |        |       |      |          | 3388            | RP 95-130       | .87         | 22,0        |     |      |
|                            |                  |        |       |      |          | 3389            | RP 95-260       | 1.38        | 35,0        |     |      |

Standard color black.

\*Bushing version of the above plug.

- Blank unused rectangular panel holes.
- PN 1890 - UR Recognized under the Component Program of Underwriters' Laboratories File E15331.
- PN 1892 - UR Recognized under the Component Program of Underwriters' Laboratories File E51579 and CSA Certified by the Canadian Standards Association File 8919.



|                     |   |
|---------------------|---|
| Material            | Nylon 6/6   |
| Certifications      | UL Recognized under the Component Program of Underwriter Laboratories File E51579 (DD only) |
| Flammability Rating | 94V-2   |
| Temperature Range   | -40°F (-40°C) to 221°F (105°C)  |

Quick Specs

“Stay Connected” with



Hole Plugs & Venting Solutions

a PennEngineering® Company



Consult Heyco for Window Tints Other Than Clear

## Heyco® Window “View Port” Plugs

Mounting Hole Diameter Range: .187” (4,7 mm) to 2.000” (50,8 mm)

- Molded of **transparent** polycarbonate for internal viewing or light transmission.
- Snap into mounting holes with fingertip pressure—no tools required.
- Multiple sizes for use in .187” (4,7 mm) to 2.000” (50,8 mm) diameter holes.
- Lock firmly into panel up to .125” (3,2 mm) thick.
- Locking fingers in fractional increments up to the maximum panel thickness.
- Approximate Head Thickness: .062” (1,6 mm). Thickness may vary.
- **Available in a variety of tints –consult Heyco.**

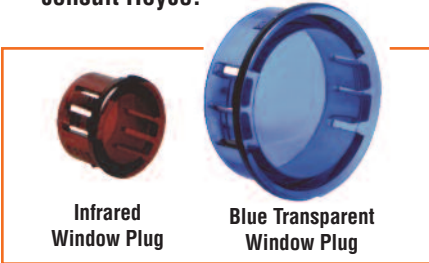

| MOUNTING HOLE DIAMETER                                       |     | PART NO.<br>Clear* | DESCRIPTION | PART DIMENSIONS    |     |                     |     |
|--|-----|--------------------|-------------|--------------------|-----|---------------------|-----|
| in.  | mm. |                    |             | A<br>Head Diameter |     | B<br>Overall Height |     |
|  |     |                    |             | in.                | mm. | in.                 | mm. |
| Single Locking Step for Panel Thickness up to .062” (1,6 mm) |     |                    |             |                    |     |                     |     |
| .187   | 4,7 | <b>1300</b>        | WP 187      | .25                | 6,4 | .23                 | 5,9 |
| .250   | 6,4 | <b>1301</b>        | WP 250      | .31                | 7,9 | .31                 | 7,9 |
| .312   | 7,9 | <b>1302</b>        | WP 312      | .38                | 9,5 |                     |     |

|   |             |             |         |      |      |     |      |
|---|-------------|-------------|---------|------|------|-----|------|
| Multiple Locking Steps for Panel Thickness up to .125” (3,2 mm) |             |             |         |      |      |     |      |
| .375  | 9,5         | <b>1303</b> | WP 375  | .47  | 11,9 | .41 | 10,3 |
| .437  | 11,1        | <b>1304</b> | WP 437  | .53  | 13,5 |     |      |
| .500  | 12,7        | <b>1305</b> | WP 500  | .56  | 14,3 |     |      |
| .625  | 15,9        | <b>1307</b> | WP 625  | .73  | 18,6 |     |      |
| .760  | 19,3        | <b>1309</b> | WP 750  | .86  | 21,8 | .45 | 11,5 |
| .875  | 22,2        | <b>1311</b> | WP 875  | .95  | 24,2 |     |      |
| 1.000   | 25,4        | <b>1312</b> | WP 1000 | 1.13 | 28,6 |     |      |
| 1.093 - 1.125   | 27,8 - 28,6 | <b>1313</b> | WP 1093 | 1.22 | 30,9 |     |      |
| 1.375   | 34,9        | <b>1314</b> | WP 1375 | 1.50 | 38,1 |     |      |
| 1.500   | 38,1        | <b>1316</b> | WP 1500 | 1.62 | 41,2 |     |      |
| 1.750   | 44,5        | <b>1318</b> | WP 1750 | 1.88 | 47,6 |     |      |
| 2.000   | 50,8        | <b>1319</b> | WP 2000 | 2.16 | 54,8 |     |      |

\*Consult Heyco for Window Plugs in tinted colors.

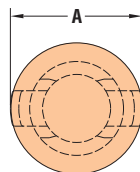

SINGLE PANEL THICKNESS DESIGN

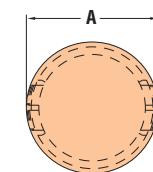
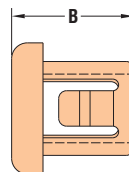

MULTIPLE PANEL THICKNESS DESIGN



- Matte Finish diffuses light from source behind plug.

ALL NEW PRODUCTS!

## Heyco® Diffuser Plugs

| MOUNTING HOLE DIAMETER*   |      | PART NO.<br>Matte | DESCRIPTION | PART DIMENSIONS    |      |                     |      |
|---|------|-------------------|-------------|--------------------|------|---------------------|------|
| in.   | mm.  |                   |             | A<br>Head Diameter |      | B<br>Overall Height |      |
|   |      |                   |             | in.                | mm.  | in.                 | mm.  |
| Multiple Locking Steps for Panel Thickness up to .125” (3,2 mm) |      |                   |             |                    |      |                     |      |
| .375  | 9,5  | <b>1303D</b>      | DWP 375     | .47                | 11,9 | .41                 | 10,3 |
| .760  | 19,3 | <b>1309D</b>      | DWP 750     | .86                | 21,8 |                     |      |
| 1.000   | 25,4 | <b>1312D</b>      | DWP 1000    | 1.13               | 28,6 | .45                 | 11,5 |
| 2.000   | 50,8 | <b>1319D</b>      | DWP 2000    | 2.16               | 54,8 |                     |      |

\*Consult Heyco for other mounting hole diameters.

|                     |                                |
|---------------------|--------------------------------|
| Material            | Polycarbonate                  |
| Flammability Rating | 94V-2                          |
| Temperature Range   | -40°F (-40°C) to 239°F (115°C) |

Quick Specs

## Heyco® Shorty Window “View Port” Plugs

Single Locking Step for Panel Thickness up to .062” (1,6 mm)  
 Mounting Hole Diameter Range: .510” (13,0 mm) to 1.010” (25,7 mm)

| MOUNTING HOLE DIAMETER |      | PART NO.<br>Clear* | DESCRIPTION       | PART DIMENSIONS    |      |                     |     |
|------------------------|------|--------------------|-------------------|--------------------|------|---------------------|-----|
| in.                    | mm.  |                    |                   | A<br>Head Diameter |      | B<br>Overall Height |     |
| .510                   | 13,0 | 1292               | SWP 510           | .56                | 14,3 | .25                 | 6,4 |
| .635                   | 16,1 | 1293               | SWP 635           | .73                | 18,6 |                     |     |
| .760                   | 19,3 | 1294               | SWP 760           | .86                | 21,8 |                     |     |
| .885                   | 22,5 | 1295               | SWP 885           | .95                | 24,2 |                     |     |
| 1.010                  | 25,7 | 1295AA             | SWP 885 Infrared* | 1.13               | 28,6 |                     |     |

\*Consult Heyco for Shorty Window Plugs in tinted colors.

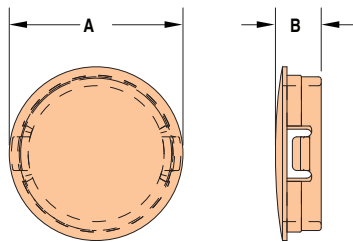

## Heyco® Oval Window “View Port” Plug

Multiple Locking Steps for Panel Thickness up to .125” (3,2 mm)

| MOUNTING HOLE DIAMETER |     | PART NO.<br>Clear* | DESCRIPTION  | PART DIMENSIONS |             |                |      |
|------------------------|-----|--------------------|--------------|-----------------|-------------|----------------|------|
| in.                    | mm. |                    |              | Head Diameter   |             | Overall Height |      |
| see schematic          |     | 1299               | OWP 875-2000 | 2.13 - 1.01     | 54,4 - 26,6 | .46            | 11,7 |

\*Consult Heyco for Oval Window Plugs in tinted colors.

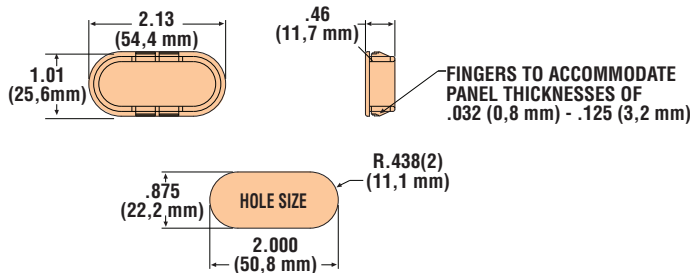

- Lock firmly into panels up to .062” (1,6 mm) thick, with **limited intrusion** inside the panel.
- Molded of transparent polycarbonate for internal viewing or light transmission.
- Snap into mounting holes with fingertip pressure—no tools required.
- Locking fingers in fractional increments up to the maximum panel thickness.
- Multiple sizes for use in .510” (13,0 mm) to 1.010” (25,7 mm) diameter holes.
- Flammability Rating 94V-2.
- **Available in a variety of tints** —consult Heyco.



- **Large viewing window** for internal components.
- Locking fingers in fractional increments up to the maximum panel thickness.

Consult Heyco for Window Tints Other Than Clear

|                     |                                |
|---------------------|--------------------------------|
| Material            | Polycarbonate                  |
| Flammability Rating | 94V-2                          |
| Temperature Range   | -40°F (-40°C) to 239°F (115°C) |

Quick Specs



Consult Heyco for our Complete Line of Dome Plugs

## Heyco® Nylon Knock Out Seals and Thick Panel Knock Out Seals

Mounting Hole Diameter Range: 1/2" to 2" Electrical Knock-outs (.875" to 2.500" nominal)

- **Plug electrical knock-outs.**
- Molded in silver gray color to resemble galvanized steel.
- Install quickly with fingertip pressure (no tool required).
- Economical.
- Multiple trade sizes fit 1/2" to 2" knock-out holes.
- Lock firmly in boxes up to 1/8" thick, except for Part Number 4002 (KOS 2) and Thick Panel Knock-Out Seals (KOST's) which lock firmly in boxes up to 1/4" thick.
- Locking fingers in fractional increments up to the maximum panel thickness.
- Approximate Head Thickness: .06" (1,6 mm). Thickness may vary.
- To adapt a Knock-Out to accept a Heyco Strain Relief, see page 4-37 for Knock-Out Adapters in the Heyco Catalog .

| MOUNTING HOLE DIAMETER |     | TRADE SIZE | PART NO.<br>Silver Gray | DESCRIPTION | PART DIMENSIONS    |  |                     |  |
|------------------------|-----|------------|-------------------------|-------------|--------------------|--|---------------------|--|
| in.                    | mm. |            |                         |             | A<br>Head Diameter |  | B<br>Overall Height |  |

Multiple Locking Steps for Panel Thickness up to .125" (3,2 mm)

|       |      |       |             |           |      |      |     |      |
|-------|------|-------|-------------|-----------|------|------|-----|------|
| .875  | 22,2 | 1/2   | <b>3997</b> | KOS 1/2   | 1.02 | 25,8 |     |      |
| 1.093 | 27,8 | 3/4   | <b>3998</b> | KOS 3/4   | 1.22 | 31,0 | .45 | 11,5 |
| 1.375 | 34,9 | 1     | <b>3999</b> | KOS 1     | 1.50 | 38,1 |     |      |
| 1.750 | 44,5 | 1-1/4 | <b>4000</b> | KOS 1-1/4 | 1.91 | 48,4 | .47 | 12,0 |
| 2.000 | 50,8 | 1-1/2 | <b>4001</b> | KOS 1-1/2 | 2.16 | 54,9 | .45 | 11,5 |

Multiple Locking Steps for Panel Thickness up to .250" (6,4 mm)

|       |      |       |             |            |      |      |     |      |
|-------|------|-------|-------------|------------|------|------|-----|------|
| .875  | 22,2 | 1/2   | <b>3991</b> | KOST 1/2   | 1.02 | 25,8 |     |      |
| 1.093 | 27,8 | 3/4   | <b>3992</b> | KOST 3/4   | 1.22 | 31,0 | .56 | 14,3 |
| 1.375 | 34,9 | 1     | <b>3993</b> | KOST 1     | 1.50 | 38,1 |     |      |
| 1.750 | 44,5 | 1-1/4 | <b>3994</b> | KOST 1-1/4 | 1.91 | 48,4 |     |      |
| 2.000 | 50,8 | 1-1/2 | <b>3995</b> | KOST 1-1/2 | 2.16 | 54,9 | .58 | 14,7 |
| 2.500 | 63,5 | 2     | <b>4002</b> | KOS 2      | 2.73 | 69,3 | .75 | 19,1 |

Standard color silver gray.

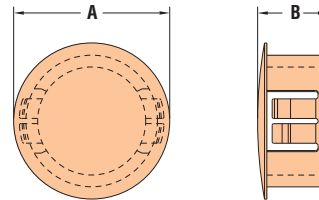

- **Molded from a nylon material which, in the event of a fire, will not burn and will not produce toxic gases.** Also formulated for sunlight resistance.

## Heyco® Nylon V-0 Knock Out Seals

Multiple Locking Steps for Panel Thickness up to .13" (3,2 mm)

Mounting Hole Diameter Range: 1/2" to 1-1/2" Electrical Knock-outs (.875" to 2.000" nominal)

| MOUNTING HOLE DIAMETER |     | TRADE SIZE | PART NO.<br>Black | DESCRIPTION | PART DIMENSIONS    |  |                     |  |
|------------------------|-----|------------|-------------------|-------------|--------------------|--|---------------------|--|
| in.                    | mm. |            |                   |             | A<br>Head Diameter |  | B<br>Overall Height |  |

|       |      |       |             |          |      |      |     |      |
|-------|------|-------|-------------|----------|------|------|-----|------|
| .875  | 22,2 | 1/2   | <b>2706</b> | HFP 875  | 1.02 | 25,8 |     |      |
| 1.093 | 27,8 | 3/4   | <b>2729</b> | HFP 1093 | 1.22 | 31,0 |     |      |
| 1.375 | 34,9 | 1     | <b>2759</b> | HFP 1375 | 1.50 | 38,1 | .45 | 11,5 |
| 1.750 | 44,5 | 1-1/4 | <b>2779</b> | HFP 1750 | 1.91 | 48,4 |     |      |
| 2.000 | 50,8 | 1-1/2 | <b>2789</b> | HFP 2000 | 2.16 | 54,9 |     |      |

Standard color black.

Quick Specs

|                     |   |
|---------------------|---|
| Material            | Nylon 6/6   |
| Certifications      | Recognized under the Component Program of Underwriters' Laboratories, File E51579<br>Certified by Canadian Standards Association, File 8919 |
| Flammability Rating | KOS: 94V-2, HFP 94V-0   |
| Temperature Range   | -40°F (-40°C) to 221°F (105°C)  |





## Heyco® V-0 Liquid Tight Hole Plugs Standard 85 Durometer Plugs

Maximum Panel Thickness .125" (3,2 mm)

Mounting Hole Diameter Range: .500" (12,7 mm) to 1.375" (34,9 mm)

| MOUNTING HOLE DIAMETER |      | PART NO.    | DESCRIPTION | UL or RA | PART DIMENSIONS |      |                  |      |                  |      |
|------------------------|------|-------------|-------------|----------|-----------------|------|------------------|------|------------------|------|
| in.                    | mm.  |             |             |          | A Head Diameter |      | B Overall Height |      | C Head Thickness |      |
|                        |      | Black       |             |          | in.             | mm.  | in.              | mm.  | in.              | mm.  |
| .500                   | 12,7 | <b>3830</b> | KOS LT 500  | RA       | .91             | 23,1 | .45              | 11,4 | .29              | 7,4  |
| .625                   | 15,9 | <b>3834</b> | KOS LT 625  | RA       | 1.03            | 26,2 | .47              | 11,9 | .31              | 7,9  |
| .750                   | 19,1 | <b>3831</b> | KOS LT 750  | RA       | 1.15            | 29,2 | .51              | 13,0 | .35              | 8,9  |
| .875                   | 22,2 | <b>3833</b> | KOS LT 1/2  | UL       | 1.23            | 32,5 | .50              | 13,5 | .36              | 9,1  |
| 1.000                  | 25,4 | <b>3832</b> | KOS LT 1000 | RA       | 1.41            | 35,8 | .56              | 14,2 | .40              | 10,2 |
| 1.093                  | 27,8 | <b>3835</b> | KOS LT 3/4  | UL       | 1.53            | 38,6 | .55              | 14,0 | .40              | 10,2 |
| 1.375                  | 34,9 | <b>3837</b> | KOS LT 1    | UL       | 1.78            | 45,2 | .57              | 14,5 | .42              | 10,7 |

Available in black only.

- Oil tight, rain tight, submersible.
- UL certified for outdoor applications.
- V0 Flammability rating.
- Install with fingertip pressure (no tool required).
- Multiple nominal sizes fit .500" (12,7 mm) to 1.000" (25,4 mm) true size mounting holes.
- Three trade sizes fit 1/2" to 1" knock-out holes.
- Lock firmly in boxes from .030" (0,8 mm) to .125" (3,2 mm) thick.
- True sizes are UL recognized under Underwriters' Laboratories File E51579 and CSA certified by Canadian Standard Association File 8919.
- Trade sizes are UL listed under Underwriters' Laboratories File E51579 and CSA certified by Canadian Standard Association File 081067C. **Now certified for NEMA 4 and 4X applications.**

## Low 75 Durometer Plugs

Maximum Panel Thickness .125" (3,2 mm)

Mounting Hole Diameter Range: .875" (22,2 mm) to 1.375" (34,9 mm)

| MOUNTING HOLE DIAMETER* |      | PART NO.      |               | DESCRIPTION   | UL or RA | PART DIMENSIONS* |      |                  |      |                  |      |
|-------------------------|------|---------------|---------------|---------------|----------|------------------|------|------------------|------|------------------|------|
| in.                     | mm.  | Black         | Gray          |               |          | A Head Diameter  |      | B Overall Height |      | C Head Thickness |      |
|                         |      |               |               |               |          | in.              | mm.  | in.              | mm.  | in.              | mm.  |
| .875                    | 22,2 | <b>3833FN</b> | <b>3833FP</b> | KOS LT 1/2 LD | UL       | 1.23             | 32,5 | .53              | 13,5 | .36              | 9,1  |
| 1.093                   | 27,8 | <b>3835FN</b> | <b>3835FP</b> | KOS LT 3/4 LD | UL       | 1.53             | 38,6 | .55              | 14,0 | .40              | 10,2 |
| 1.375                   | 34,9 | <b>3837FN</b> | <b>3837FP</b> | KOS LT 1 LD   | UL       | 1.80             | 45,2 | .56              | 14,3 | .42              | 10,7 |

Standard colors black and gray.

\*Consult Heyco for other Liquid Tight Hole Plug sizes in Low Durometer material.

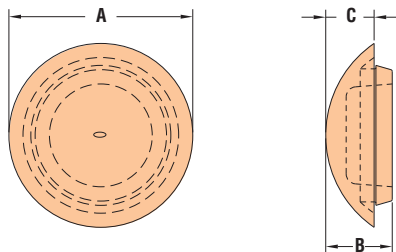

|                     |                              |  |
|---------------------|------------------------------|--|
| Material            | 85 Durometer<br>75 Durometer | TPE-Hardness 85 Shore A<br>TPE-Hardness 75 Shore A   |
| Certifications      | Trade Sizes (1/2, 3/4, 1)    | UL Listed under Underwriters' Laboratories File E51579<br>CSA Certified by Canadian Standard Association File 081067C  |
|                     | True Sizes (all others)      | RA Recognized under Underwriters' Laboratories File E51579<br>CSA Certified by Canadian Standard Association File 8919 |
| Flammability Rating |                              | 94V-0  |
| Temperature Range   |                              | -81°F (-60°C) to 275°F (135°C)   |

Quick Specs

"Stay Connected" with



Hole Plugs & Venting Solutions

a PennEngineering® Company



## Heyco® Nylon Liquid Tight Threaded Plugs

Liquid Tight, with Integral Sealing Ring  
Hex Head with Slot

NO O-RING  
REQUIRED!

- **Integral sealing ring** ensures a superior seal at mounting hole location, every time.
- IP 68 Rated.
- Provide a liquid-tight seal up to 70 psi.
- UL Rated for Type NEMA 3R, 4 and 4X applications.
- Threaded plugs for hydraulic and pneumatic applications.
- Seal threaded openings and protect against contamination and moisture.
- Lower cost option over brass or steel plugs.
- Non-corrosive—resist salt water, weak acids, gasoline, alcohol, oil, grease, and common solvents.
- Resist oil and heat up to 221°F (105°C).
- Approximate Head Thickness: .21" (5,3 mm). Thickness may vary.
- Hex shaped head with slot for wrench or screwdriver installation.
- Electrically non-conductive Nylon 6/6.

| THREAD<br>TYPE/SIZE | PART NO. |      |                            | DESCRIPTION | PART DIMENSIONS      |     |                     |  |
|---------------------|----------|------|----------------------------|-------------|----------------------|-----|---------------------|--|
|                     | Black    | Gray | V-0<br>Black<br><b>NEW</b> |             | A<br>Wrenching Flats |     | B<br>Overall Length |  |
|                     | in.      | mm.  |                            | in.         | mm.                  | in. | mm.                 |  |

### NPT

|            |       |      |        |                |      |      |      |      |
|------------|-------|------|--------|----------------|------|------|------|------|
| NPT 1/4    | 3544B | 3544 | -      | LTTT NPT 1/4   | .63  | 16,0 | .66  | 16,8 |
| NPT 3/8    | 3545B | 3545 | -      | LTTT NPT 3/8   | .83  | 21,1 | .69  | 17,5 |
| NPT 1/2    | 3546B | 3546 | V3546* | LTTT NPT 1/2   | .98  | 24,9 | .81  | 20,6 |
| NPT 3/4    | 3547B | 3547 | V3547* | LTTT NPT 3/4   | 1.29 | 32,8 | .86  | 21,8 |
| NPT 1*     | 3548B | 3548 | V3548  | LTTT NPT 1     | 1.74 | 44,2 | 1.05 | 26,7 |
| NPT 1-1/4* | 3549B | 3549 | V3549  | LTTT NPT 1-1/4 | 2.06 | 52,3 | 1.08 | 27,4 |

PG - for PG Thread Specifications, see page 3-49

|         |       |      |   |              |      |      |     |      |
|---------|-------|------|---|--------------|------|------|-----|------|
| PG 7    | 3574B | 3574 | - | LTTT PG 7    | .63  | 16,0 | .53 | 13,5 |
| PG 9    | 3575B | 3575 | - | LTTT PG 9    | .83  | 21,0 |     |      |
| PG 13.5 | 3576B | 3576 | - | LTTT PG 13.5 | .98  | 24,9 | .62 | 15,8 |
| PG 21   | 3401B | 3401 | - | LTTT PG 21   | 1.29 | 32,8 | .68 | 17,3 |
| PG 29*  | 3578B | 3578 | - | LTTT PG 29   | 1.74 | 44,2 | .87 | 22,1 |
| PG 36*  | 3579B | 3579 | - | LTTT PG 36   | 2.06 | 52,3 | .78 | 19,8 |

### Metric

|      |       |      |   |          |      |      |     |      |
|------|-------|------|---|----------|------|------|-----|------|
| M12  | 3582B | 3582 | - | LTTT M12 | .63  | 16,0 | .53 | 13,5 |
| M16  | 3583B | 3583 | - | LTTT M16 | .83  | 21,1 |     |      |
| M20  | 3584B | 3584 | - | LTTT M20 | .98  | 24,9 | .62 | 15,8 |
| M32* | 3586B | 3586 | - | LTTT M32 | 1.74 | 44,2 | .87 | 22,1 |
| M40* | 3587B | 3587 | - | LTTT M40 | 2.06 | 52,3 | .78 | 19,8 |

Standard colors black and gray. Consult Heyco for other colors, and sizes in V-0 material.  
\*Not cURus.

**NEW**

### Available in Small Packs

| PART NO. | DESCRIPTION              | QTY |
|----------|--------------------------|-----|
| 3546-P   | LTTT NPT 1/2 Gray 100PK  | 100 |
| 3547-P   | LTTT NPT 3/4 Gray 100PK  | 100 |
| 3548-P   | LTTT NPT 1 Gray 100PK    | 100 |
| 3549-P   | LTTT NPT 1-1/4 Gray 50PK | 50  |

Standard color gray.

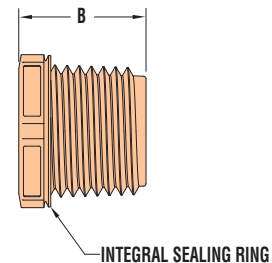
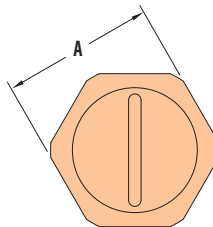

*Quick  
Specs*

|                     |   |
|---------------------|---|
| Material            | Nylon 6/6   |
| Certifications      | cULus Recognized under the Component Program of Underwriters' Laboratories, File E330194 to both Canadian and U.S. Requirements |
| Flammability Rating | 94V-2   |
| Temperature Range   | -40°F (-40°C) to 221°F (105°C)  |
| IP Rating           | IP 68 (70 PSI, 5 BAR)   |

“Stay Connected” with



Hole Plugs & Venting Solutions

a PennEngineering® Company



## HEYCo-molded™ Liquid Tight Break-Thru Plugs

Mounting Hole Diameter Range: .500" (12,7 mm) to 1.500" (38,1 mm)

Small Packs Available

| PANEL DIMENSIONS   |     |                         |      | CABLE DIAMETER RANGE |            | PART NO.<br>Black | PACKAGING  |              | DESCRIPTION   | PART DIMENSIONS |      |                  |      |
|--|-----|-------------------------|------|----------------------|------------|-------------------|------------|--------------|---------------|-----------------|------|------------------|------|
| Thickness at Locking Finger Steps  |     | Mounting Hole Diameter* |      | in.                  | mm.        |                   | BULK (Std) | SMALL PACK** |               | A Head Diameter |      | B Overall Height |      |
| in.  | mm. | in.                     | mm.  | in.                  | mm.        |                   |            | in.          | mm.           | in.             | mm.  |                  |      |
| With Five Locking Finger Steps for Panels up to .063" (1,6 mm) Thick                   |     |                         |      |                      |            |                   |            |              |               |                 |      |                  |      |
| .020   | 0,5 | .500                    | 12,7 | .080 - .200          | 2,0 - 5,1  | <b>C2008</b>      | 1000       | 10           | LTBP 500-063  | .92             | 23,4 |                  |      |
| .032   | 0,8 | .625                    | 15,9 | .130 - .375          | 3,3 - 9,5  | <b>C2012</b>      | 1000       | 10           | LTBP 625-063  | 1.03            | 26,2 |                  |      |
| .040   | 1,0 | .750                    | 19,1 | .175 - .400          | 4,4 - 10,2 | <b>C2016</b>      | 1000       | 10           | LTBP 750-063  | 1.15            | 29,2 | .32              | 8,1  |
| .048   | 1,2 | .875                    | 22,2 | .130 - .450          | 3,3 - 11,4 | <b>C2020</b>      | 1000       | 10           | LTBP 875-063  | 1.28            | 32,5 |                  |      |
| .063   | 1,6 | 1.000                   | 25,4 | .200 - .715          | 5,1 - 18,2 | <b>C2022</b>      | 1000       | 10           | LTBP 1000-063 | 1.43            | 36,3 |                  |      |
|  |     | 1.093                   | 27,8 | .250 - .765          | 6,4 - 19,4 | <b>C2024</b>      | 1000       | 10           | LTBP 1093-063 | 1.53            | 38,9 |                  |      |
| With Seven Locking Finger Steps for Panels from .063" (1,6 mm) to .250" (6,4 mm) Thick |     |                         |      |                      |            |                   |            |              |               |                 |      |                  |      |
| .063   | 1,6 | .500                    | 12,7 | .080 - .200          | 2,0 - 5,1  | <b>C2058</b>      | 1000       | 10           | LTBP 500-250  | .92             | 23,4 |                  |      |
| .080   | 2,0 | .625                    | 15,9 | .130 - .375          | 3,3 - 9,5  | <b>C2062</b>      | 1000       | 10           | LTBP 625-250  | 1.03            | 26,2 |                  |      |
| .094   | 2,4 | .750                    | 19,1 | .175 - .400          | 4,4 - 10,2 | <b>C2066</b>      | 1000       | 10           | LTBP 750-250  | 1.15            | 29,2 | .63              | 15,9 |
| .125   | 3,2 | .875                    | 22,2 | .130 - .450          | 3,3 - 11,4 | <b>C2070</b>      | 1000       | 10           | LTBP 875-250  | 1.28            | 32,5 |                  |      |
| .157   | 4,0 | 1.000                   | 25,4 | .200 - .715          | 5,1 - 18,2 | <b>C2072</b>      | 1000       | 10           | LTBP 1000-250 | 1.43            | 36,3 |                  |      |
| .200   | 5,1 | 1.093                   | 27,8 | .250 - .765          | 6,4 - 19,4 | <b>C2074</b>      | 1000       | 10           | LTBP 1093-250 | 1.53            | 38,9 |                  |      |
| .250   | 6,4 | 1.375                   | 34,9 | .300 - .950          | 7,6 - 24,1 | <b>C2080</b>      | 1000       | 10           | LTBP 1375-250 | 1.80            | 45,7 | .67              | 17,0 |
|  |     | 1.500                   | 38,1 | .375 - 1.060         | 9,5 - 26,9 | <b>C2082</b>      | 1000       | 10           | LTBP 1500-250 | 1.93            | 49,0 |                  |      |

Standard color black. Consult Heyco for other colors.

\*Consult Heyco for other Mounting Hole Diameters. Our Axcell Rapid Response Team is ready to meet your requirements.

\*\*To order Small Packs, please add the suffix -P to Part No., e.g., C2008-P

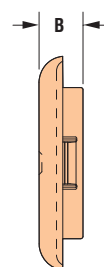
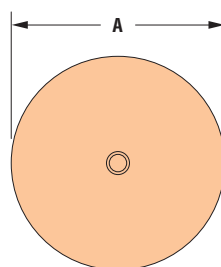

- These **co-molded** nylon and elastomer parts function as **Liquid Tight Plugs** with an IP 67/68 rating, yet can be pierced by **round wire, cable or tubing** to function as **Liquid Tight Bushings** with the same resulting IP 67/68 rating.
- **Certified by UL under UL 635**
- For use in panels as thin as .020" (0,5 mm) and as thick as .250" (6,4 mm).
- Provide liquid tight closure when used as a plug. When pierced, function as a liquid tight bushing that convert raw edged holes to smooth, neat, insulated holes.
- Used as a liquid tight bushing, HEYCo-molded Liquid Tight Break-Thru Plugs insulate and mechanically protect electrical and telecommunications cable, tubing, hose, rope, and utility lines.
- Locking fingers snap into holes with fingertip pressure.
- Locking fingers in fractional increments up to the maximum panel thickness.
- Withstand a push back force of greater than 35 pounds.
- Available in multiple sizes for use in .500" (12,7 mm) to 1.500" (38,1 mm) diameter holes.

|                     |  |
|---------------------|--|
| Materials           | Nylon 6/6 and TPE  |
| Certifications      | Recognized under the Component Program of Underwriters' Laboratories File E15331 |
| Flammability Rating | HB   |
| Temperature Range   | -40°F (-40°C) to 212°F (100°C)   |
| IP Rating           | 67/68  |



- DSC Series Caps are designed to provide **electrostatic discharge protection** for rectangular D-subminiature input/output type connectors.
- Designed with an **integral flange** for easy application and removal.
- Fit over both **Standard Density** and **High Density** D-Sub Shells.
- Molded in pink dissipative ethylene vinyl acetate, which **meets the static decay requirements** of MIL-PRF-81705D: Surface resistivity less than  $1 \times 10^{12}$  ohms/sq.
- For similar schematic drawings see D-Subminiature Mounting Hole Plugs, see page 6-42.

## HEYCap™ D-Subminiature Protection Caps

| Shell Designation & Type | SHELL DIMENSIONS |     |          |      | PART NO. Pink* | DESCRIPTION  | PART DIMENSIONS |      |      |     |        |      |      |     |      |
|--------------------------|------------------|-----|----------|------|----------------|--------------|-----------------|------|------|-----|--------|------|------|-----|------|
|                          | A Width          |     | B Length |      |                |              | C Head          |      |      |     | E Body |      |      |     |      |
|                          | in.              | mm. | in.      | mm.  |                |              | in.             | mm.  | in.  | mm. | in.    | mm.  | in.  | mm. |      |
| 1 or E                   | 9 Socket         | .31 | 7,9      | .64  | 16,3           | <b>G5160</b> | DSC 1S          | .79  | 20,1 | .45 | 11,4   | .72  | 18,2 | .38 | 9,5  |
|                          | 9 Pin            | .33 | 8,4      | .67  | 16,9           | <b>G5161</b> | DSC 1P          | .86  | 21,8 | .51 | 12,9   | .78  | 19,8 | .43 | 10,9 |
| 2 or A                   | 15 Socket        | .31 | 7,9      | .97  | 24,6           | <b>G5162</b> | DSC 2S          | 1.10 | 27,9 | .45 | 11,4   | 1.04 | 26,4 | .38 | 9,5  |
|                          | 15 Pin           | .33 | 8,4      | .99  | 25,2           | <b>G5163</b> | DSC 2P          | 1.19 | 30,2 | .51 | 12,9   | 1.12 | 28,3 | .43 | 10,9 |
| 3 or B                   | 25 Socket        | .33 | 7,9      | 1.51 | 38,3           | <b>G5164</b> | DSC 3S          | 1.66 | 42,2 | .46 | 11,7   | 1.12 | 28,3 | .37 | 9,4  |
|                          | 25 Pin           | .31 | 8,4      | 1.53 | 40,0           | <b>G5165</b> | DSC 3P          | 1.70 | 43,2 | .52 | 13,2   | 1.58 | 40,2 | .43 | 11,0 |
| 4 or C                   | 37 Socket        | .31 | 7,9      | 2.16 | 54,8           | <b>G5166</b> | DSC 4S          | 2.29 | 58,2 | .45 | 11,4   | 1.61 | 41,0 | .37 | 9,3  |
|                          | 37 Pin           | .33 | 8,4      | 2.18 | 55,4           | <b>G5167</b> | DSC 4P          | 2.37 | 60,2 | .52 | 13,2   | 1.23 | 30,5 | .45 | 11,4 |
| 5 or D                   | 50 Socket        | .42 | 10,7     | 2.06 | 52,4           | <b>G5168</b> | DSC 5S          | 2.21 | 56,1 | .56 | 14,2   | 2.15 | 54,5 | .49 | 12,3 |
|                          | 50 Pin           | .44 | 11,1     | 2.08 | 52,8           | <b>G5169</b> | DSC 5P          | 2.27 | 57,6 | .62 | 15,7   | 2.20 | 55,8 | .55 | 14,0 |
| 6                        | 104 Socket       | .49 | 12,3     | 2.19 | 55,6           | <b>G5170</b> | DSC 6S          | 2.35 | 59,7 | .65 | 16,5   | 2.27 | 57,6 | .56 | 14,3 |
|                          | 104 Pin          | .50 | 12,8     | 2.21 | 56,2           | <b>G5171</b> | DSC 6P          | 2.44 | 62,0 | .70 | 17,8   | 2.29 | 58,2 | .58 | 14,8 |

\* Material: Pink Static Dissipative Ethylene Vinyl Acetate (EVA). Black Conductive Polyethylene Copolymer also available, please consult Heyco.



- EMC Series Caps fit 36- and 68-pin Champ 050 series connectors and 50-pin Champ-type connectors.
- Designed with an **integral flange** for easy application and removal.
- Molded in pink dissipative ethylene vinyl acetate, which **meets the static decay requirements** of MIL-PRF-81705D: Surface resistivity less than  $1 \times 10^{12}$  ohms/sq.
- For similar schematic drawings see D-Subminiature Mounting Hole Plugs, see page 6-42.

## HEYCap™ Electro Miniature Protection Caps

| Typical Configuration | SHELL DIMENSIONS |      |          |      | PART NO. Pink* | DESCRIPTION | PART DIMENSIONS |      |     |      |        |      |     |      |
|-----------------------|------------------|------|----------|------|----------------|-------------|-----------------|------|-----|------|--------|------|-----|------|
|                       | A Width          |      | B Length |      |                |             | C Head          |      |     |      | E Body |      |     |      |
|                       | in.              | mm.  | in.      | mm.  |                |             | in.             | mm.  | in. | mm.  | in.    | mm.  | in. | mm.  |
| 36 Pin                | .25              | 6,4  | 1.05     | 26,7 | <b>G5172</b>   | EMC 36      | 1.18            | 30,0 | .40 | 10,2 | 1.11   | 27,9 | .31 | 7,9  |
| 50 Pin                | .48              | 12,1 | 2.51     | 63,5 | <b>G5173</b>   | EMC 50      | 2.63            | 66,8 | .60 | 15,2 | 2.57   | 65,1 | .54 | 13,6 |
| 68 Pin                | .26              | 6,6  | 1.83     | 46,5 | <b>G5174</b>   | EMC 68      | 1.95            | 49,5 | .38 | 9,6  | 1.89   | 48,0 | .32 | 8,1  |

\* Material: Pink Static Dissipative Ethylene Vinyl Acetate (EVA). Black Conductive Polyethylene Copolymer also available, please consult Heyco.

Quick Specs

Material  
Temperature Range

Pink Static Dissipative Ethylene Vinyl Acetate (EVA)  
-98°F (-68°C) to 140°F (60°C)



## Heyco® Nylon D-Subminiature Mounting Hole Plugs

Clearance Fit for Panel Thickness up to .170" (4,3 mm)

| MOUNTING HOLE SIZE |      |      |      | PART NO.    | DESCRIPTION | PART DIMENSIONS |      |      |      |      |      |      |      |   |  |   |
|--------------------|------|------|------|-------------|-------------|-----------------|------|------|------|------|------|------|------|---|--|---|
| A                  |      | B    |      |             |             | C               |      |      |      | D    |      |      |      | E |  | F |
| in.                | mm.  | in.  | mm.  |             |             | Head            |      | Body |      | Head |      | Body |      |   |  |   |
|                    |      |      |      | Black       |             |                 |      |      |      |      |      |      |      |   |  |   |
| .45                | 11,4 | .81  | 20,6 | <b>2966</b> | POP-DB9     | 1.25            | 31,8 | .70  | 17,8 | .69  | 17,5 | .41  | 10,4 |   |  |   |
|                    |      | 1.13 | 28,8 | <b>2968</b> | POP-DB15    | 1.57            | 39,8 | .70  | 17,8 | 1.05 | 26,7 |      |      |   |  |   |
|                    |      | 1.67 | 42,5 | <b>2970</b> | POP-DB25    | 2.12            | 51,0 | .70  | 17,8 | 1.55 | 39,4 |      |      |   |  |   |
|                    |      | 2.32 | 59,1 | <b>2972</b> | POP-DB37    | 2.77            | 70,4 | .70  | 17,8 | 2.23 | 56,6 |      |      |   |  |   |

Standard color black. Consult Heyco for other colors.

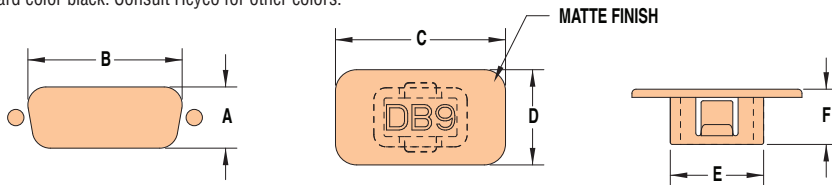

- Fit standard D-Subminiature Cutouts.
- Provide aesthetic improvement for unused D-subminiature connector mounting holes.
- Suitable for use as dust protection for unused parallel and serial ports on computers and other electrical equipment.
- Cover unwanted holes in panel and are easily removable.
- Quick and easy installation with fingertip pressure.

Custom Color Match and Special Engraved Identification Available. Consult Heyco for Details

|                     |   |
|---------------------|---|
| Material            | Nylon 6/6   |
| Certifications      | Recognized under the Component Program of Underwriters' Laboratories, File E51579<br>Certified by Canadian Standards Association, File 8919 |
| Flammability Rating | 94V-2   |
| Temperature Range   | -40°F (-40°C) to 221°F (105°C)  |

Quick Specs

## Heyco® IEC-14 Plug

For IEC-13 Female Connectors

| PART NO.     | DESCRIPTION | PART DIMENSIONS |      |     |      |     |     |
|--------------|-------------|-----------------|------|-----|------|-----|-----|
|              |             | A               |      | B   |      | C   |     |
| Black        |             | in.             | mm.  | in. | mm.  | in. | mm. |
| <b>G5365</b> | IECP C14    | .96             | 24,4 | .66 | 16,8 | .38 | 9,7 |

Standard color black.

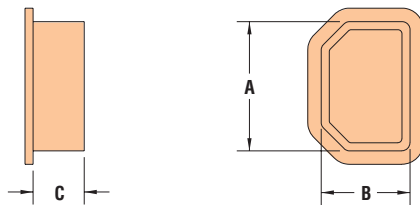

- These non-conductive plugs are used to protect female IEC-13 connectors during transit and storage.
- Will keep your connector free of dust, moisture, and contaminants.
- The flanged Plug head provides ease of installation and removal.
- Consult Heyco for the IEC-20 Plug (for IEC-19 female connectors).

|                   |                               |
|-------------------|-------------------------------|
| Material          | LDPE                          |
| Temperature Range | -94°F (-70°C) to 150°F (66°C) |

Quick Specs



**USB-A Cap**

- Silicone material for high temperature applications up to 302°F (150°C).
- Protects adapter's internal components with stress-free installation.

**USB-B Cap**

- Non-conductive, inexpensive, protects USB-B ports.
- Shields female ports from dust, moisture, and contaminants.
- USB-B plugs have a convenient pull-tab for quick and easy removal.
- Applicable Specs: USB-B MS-90376-Y, MS-25177, NAS-820, NAS-837



**CP-RJ Plugs**

- Silicone material for high temperature applications up to 302° F (150° C).
- Protects adapter's internal components with stress-free installation.
- For Heyco Connector Port Plugs, **Part Nos. 3388 and 3389**, see page 6-34.

**Heyco® Connector Caps and Plugs**

| PART NO.<br>Black   | DESCRIPTION | PART DIMENSIONS |      |     |      |     |      |
|---------------------|-------------|-----------------|------|-----|------|-----|------|
|                     |             | A               |      | B   |      | C   |      |
|                     |             | in.             | mm.  | in. | mm.  | in. | mm.  |
| <b>USB Series</b>   |             |                 |      |     |      |     |      |
| 2960                | USB-A Cap*  | .48             | 12,2 | .18 | 4,6  | .44 | 11,1 |
| 2962                | USB-B Plug  | .36             | 9,0  | .25 | 6,4  | .25 | 6,4  |
| <b>CP-RJ Series</b> |             |                 |      |     |      |     |      |
| 2967                | CP-RJ11     | .41             | 10,4 | .41 | 10,4 | .33 | 8,4  |
| 2969                | CP-RJ45     | .49             | 12,4 |     |      |     |      |

\*USB-A Cap color is red.

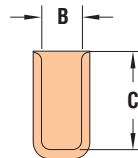
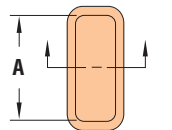

USB-A

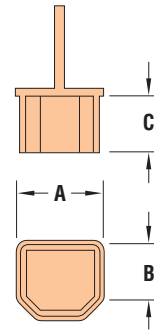

USB-B

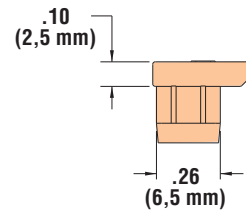
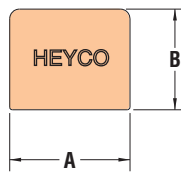

CP-RJ

*Quick Specs*

|                   | USB-A                         | USB-B                       | CP-RJxx                        |
|-------------------|-------------------------------|-----------------------------|--------------------------------|
| Material          | Vinyl                         | LDPE                        | Silicone Rubber                |
| Fammability Rate  | HB                            | HB                          | HB                             |
| Temperature Range | -26°F (-32°C) to 200°F (93°C) | 0°F (-18°C) to 175°F (79°C) | -26°F (-32°C) to 400°F (204°C) |

## Heyco® PG and Metric Threaded Plugs

Round Head with Slot

Plastic

| THREAD TYPE/SIZE                | PART NO. |       | DESCRIPTION | PART DIMENSIONS    |      |                     |      |
|---------------------------------|----------|-------|-------------|--------------------|------|---------------------|------|
|                                 | Gray     | Black |             | A<br>Head Diameter |      | B<br>Overall Height |      |
|                                 |          |       |             | in.                | mm.  | in.                 | mm.  |
| <b>PG Threads - Polystyrene</b> |          |       |             |                    |      |                     |      |
| PG 7                            | 3405     | 3405B | TP PG 7     | .59                | 15,0 | .32                 | 8,0  |
| PG 9                            | 3407     | 3407B | TP PG 9     | .75                | 19,0 | .37                 | 9,5  |
| PG 11                           | 3402     | 3402B | TP PG 11    | .87                | 22,0 |                     |      |
| PG 13                           | 3412     | 3412B | TP PG 13    | .98                | 25,0 | .39                 | 10,0 |
| PG 16                           | 3414     | 3414B | TP PG 16    | 1.06               | 27,0 |                     |      |
| PG 21                           | 3416     | 3416B | TP PG 21    | 1.30               | 33,0 |                     |      |
| PG 29                           | 3418     | 3418B | TP PG 29    | 1.73               | 44,0 | .47                 | 12,0 |
| PG 36                           | 3415     | 3415B | TP PG 36    | 2.17               | 55,0 | .55                 | 14,0 |
| <b>NEW!</b> PG 42               | 3400     | 3400B | TP PG 42    | 2.44               | 62,0 |                     |      |
| PG 48                           | 3417     | 3417B | TP PG 48    | 2.72               | 69,0 | .63                 | 16,0 |

### Metric Threads - Nylon

|           |      |       |        |      |      |     |      |
|-----------|------|-------|--------|------|------|-----|------|
| M12 x 1,5 | 3403 | 3403B | TP M12 | .59  | 15,0 |     |      |
| M16 x 1,5 | 3404 | 3404B | TP M16 | .79  | 20,0 | .41 | 10,5 |
| M20 x 1,5 | 3406 | 3406B | TP M20 | .95  | 24,0 |     |      |
| M25 x 1,5 | 3408 | 3408B | TP M25 | 1.18 | 30,0 | .51 | 13,0 |
| M32 x 1,5 | 3409 | 3409B | TP M32 | 1.48 | 37,0 | .53 | 13,5 |
| M40 x 1,5 | 3410 | 3410B | TP M40 | 1.81 | 46,0 | .55 | 14,0 |
| M50 x 1,5 | 3411 | 3411B | TP M50 | 2.20 | 56,0 | .63 | 16,0 |
| M63 x 1,5 | 3413 | 3413B | TP M63 | 2.76 | 70,0 | .71 | 18,0 |

Standard color gray and black. Consult Heyco for other colors.

## Nickel-Plated Brass

ALL NEW PRODUCTS!

| THREAD TYPE/SIZE      | PART NO. |  | DESCRIPTION    | PART DIMENSIONS    |      |                     |      |
|-----------------------|----------|--|----------------|--------------------|------|---------------------|------|
|                       |          |  |                | A<br>Head Diameter |      | B<br>Overall Height |      |
|                       |          |  |                | in.                | mm.  | in.                 | mm.  |
| <b>PG Threads</b>     |          |  |                |                    |      |                     |      |
| PG 7                  | 13405    |  | BRASS TP PG 7  | .55                | 14,0 | .31                 | 8,0  |
| PG 9                  | 13407    |  | BRASS TP PG 9  | .67                | 17,0 |                     |      |
| PG 11                 | 13402    |  | BRASS TP PG 11 | .79                | 20,0 | .35                 | 9,0  |
| PG 13                 | 13412    |  | BRASS TP PG 13 | .87                | 22,0 |                     |      |
| PG 16                 | 13414    |  | BRASS TP PG 16 | .94                | 24,0 | .37                 | 9,5  |
| PG 21                 | 13416    |  | BRASS TP PG 21 | 1.18               | 30,0 | .43                 | 11,0 |
| PG 29                 | 13418    |  | BRASS TP PG 29 | 1.54               | 39,0 | .47                 | 12,0 |
| PG 36                 | 13415    |  | BRASS TP PG 36 | 1.97               | 50,0 | .59                 | 15,0 |
| PG 42                 | 13400    |  | BRASS TP PG 42 | 2.36               | 60,0 |                     |      |
| PG 48                 | 13417    |  | BRASS TP PG 48 | 2.56               | 65,0 | .63                 | 16,0 |
| <b>Metric Threads</b> |          |  |                |                    |      |                     |      |
| M6 x1.0               | 13397    |  | BRASS TP M6*   | .35                | 9,0  |                     |      |
| M8 x1.25              | 13398    |  | BRASS TP M8*   | .39                | 10,0 |                     |      |
| M10 x1.5              | 13399    |  | BRASS TP M10*  | .47                | 12,0 | .31                 | 8,0  |
| M12 x 1,5             | 13403    |  | BRASS TP M12   | .55                | 14,0 |                     |      |
| M16 x 1,5             | 13404    |  | BRASS TP M16   | .75                | 19,0 |                     |      |
| M20 x 1,5             | 13406    |  | BRASS TP M20   | .94                | 24,0 | .35                 | 9,0  |
| M25 x 1,5             | 13408    |  | BRASS TP M25   | 1.10               | 28,0 | .43                 | 11,0 |
| M32 x 1,5             | 13409    |  | BRASS TP M32   | 1.38               | 35,0 | .47                 | 12,0 |
| M40 x 1,5             | 13410    |  | BRASS TP M40   | 1.77               | 45,0 | .55                 | 14,0 |
| M50 x 1,5             | 13411    |  | BRASS TP M50   | 2.17               | 55,0 | .59                 | 15,0 |
| M63 x 1,5             | 13413    |  | BRASS TP M63   | 2.76               | 70,0 | .63                 | 16,0 |

### Metric Threads

\* Metric course-pitch threads

|                     | Plastic TP Plugs                          | Brass TP Plugs                         |
|---------------------|---|--|
| Material            | Nylon 6/6 or Impact Resistant Polystyrene | Nickel-Plated Brass with an NBR O-ring |
| Flammability Rating | 94V-2                                     |  |
| Temperature Range   | -4° F (-20° C) to 176° F (80° C)          | -40° F (-40° C) to 212° F (100° C)     |
| IP Rating           | IP 50                                     | IP 68                                  |



- Used to close **unnecessary PG and Metric threaded holes** when other threaded accessories may be added at a later time.
- Designed with slot for screwdriver installation
- For PG Threaded specifications, see page 3-57
- For Heyco Snap-In Metric Dome Plugs, see page 6-30.
- Nickel-Plated Brass Plugs are ideal where extra durability and strength are needed such as harsh environmental conditions.
- Nickel-Plated Brass Plugs include NBR O-ring

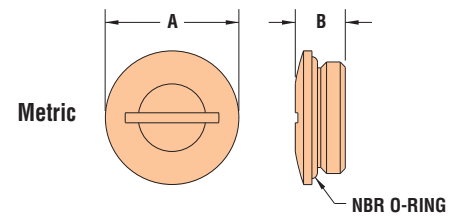
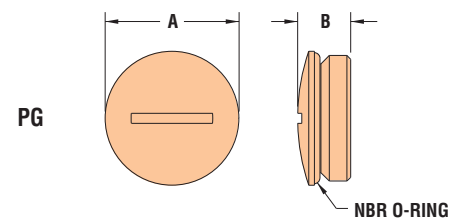
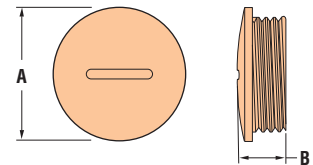

Quick Specs

“Stay Connected” with



Hole Plugs & Venting Solutions

a PennEngineering® Company



**For NPT/NPS Threaded Ports**

- Provide a positive seal on threaded ports.
- Flange (if applicable) compresses against the mounting hole surface area, keeping contaminants from the spot face.
- **For NPT:** Square Head; Part Nos. G5404 and G5405 have integral Shoulder Washer.
- **For NPS:** Round, 12 point “socket pattern” Head with integral, serrated Shoulder Washer.
- Applicable Specs. MIL-C-52078, MIL-C-5501/5, NAS 840.
- Red color.

**Heyco® Plugs for Threaded Ports**

| THREADED PORT | PART NO. | DESCRIPTION | PART DIMENSIONS                         |            |     |                     |     |                           |     |
|---------------|----------|-------------|---|------------|-----|---------------------|-----|---------------------------|-----|
|               |          |             | A<br>Square or 12-Point<br>Socket Head* | B<br>Depth |     | C<br>Head<br>Height |     | D<br>Shoulder<br>Diameter |     |
|               |          |             |   | in.        | mm. | in.                 | mm. | in.                       | mm. |

**For NPT Threaded Ports - Square Head - Red Color**

**ALL NEW PRODUCTS**

|       |       |               |      |     |      |     |     |      |      |
|-------|-------|---------------|------|-----|------|-----|-----|------|------|
| 1/8   | G5400 | PNPT 1/8      | .28  | .44 | 11,2 | .25 | 6,4 |      |      |
| 1/4   | G5401 | PNPT 1/4      | .37  | .48 | 12,2 | .25 | 6,4 | n/a  | n/a  |
| 3/8   | G5402 | PNPT 3/8      | .44  | .56 | 14,2 | .25 | 6,4 |      |      |
| 1/2   | G5403 | PNPT 1/2      | .56  | .59 | 15,0 | .25 | 6,4 |      |      |
| 3/4   | G5404 | PNPS 3/4-S ** | .62  | .62 | 15,7 | .25 | 6,4 | 1.11 | 28,3 |
| 1     | G5405 | PNPS 1-S **   | .81  | .72 | 18,3 | .31 | 7,9 | 1.40 | 35,6 |
| 1-1/4 | G5406 | PNPT 1-1/4    | 1.00 | .75 | 19,1 | .35 | 8,9 | n/a  | n/a  |
| 1-1/2 | G5407 | PNPT 1-1/2    | 1.25 | .94 | 23,9 | .38 | 9,7 |      |      |

**For NPS Threaded Ports - 12 Point Head - Red Color**

|     |       |          |      |     |      |     |      |      |      |
|-----|-------|----------|------|-----|------|-----|------|------|------|
| 1/8 | G5410 | PNPS 1/8 | 9/16 | .27 | 6,9  | .31 | 7,9  | .56  | 14,2 |
| 1/4 | G5411 | PNPS 1/4 | 9/16 | .37 | 9,4  | .31 | 7,9  | .74  | 18,8 |
| 3/8 | G5412 | PNPS 3/8 | 9/16 | .33 | 8,4  | .38 | 9,7  | .83  | 21,1 |
| 1/2 | G5413 | PNPS 1/2 | 9/16 | .55 | 14,0 | .37 | 9,4  | 1.04 | 26,4 |
| 3/4 | G5414 | PNPS 3/4 | 9/16 | .63 | 16,0 | .41 | 10,4 | 1.31 | 33,3 |

**For SAE Threaded Ports - 12 Point Head - Red Color - with Integral Sealing Ring\***

|           |       |                |        |     |      |     |     |      |      |
|-----------|-------|----------------|--------|-----|------|-----|-----|------|------|
| 7/16-24   | G5420 | PSAE 7/16-24   | 3/8    | .34 | 8,6  | .26 | 6,6 | .66  | 16,8 |
| 7/16-20   | G5421 | PSAE 7/16-20   |        |     |      |     |     |      |      |
| 1/2-20    | G5422 | PSAE 1/2-20    | 7/16   | .34 | 8,6  | .30 | 7,6 | .73  | 18,5 |
| 9/16-18   | G5423 | PSAE 9/16-18   | 1/2    | .36 | 9,1  | .30 | 7,6 | .80  | 20,3 |
| 3/4-16    | G5424 | PSAE 3/4-16    | 11/16  | .41 | 10,4 | .31 | 7,9 | 1.02 | 25,9 |
| 7/8-14    | G5425 | PSAE 7/8-14    | 13/16  | .53 | 13,5 | .31 | 7,9 | 1.16 | 29,5 |
| 1-1/16-12 | G5426 | PSAE 1-1/16-12 | 1      | .61 | 15,5 | .31 | 7,9 | 1.45 | 36,8 |
| 1-5/16-12 | G5427 | PSAE 1-5/16-12 | 1-1/4  | .61 | 15,5 | .33 | 8,4 | 1.74 | 44,2 |
| 1-5/8-12  | G5428 | PSAE 1-5/8-12  | 1-9/16 | .61 | 15,5 | .33 | 8,4 | 2.17 | 55,1 |
| 1-7/8-12  | G5429 | PSAE 1-7/8-12  | 1-7/8  | .62 | 15,7 | .34 | 8,6 | 2.42 | 61,5 |

**For ISO Threaded Ports - Green Color - with Integral Sealing Ring**

|          |       |         |    |     |      |     |      |      |      |
|----------|-------|---------|----|-----|------|-----|------|------|------|
| 10 x 1.5 | G5431 | PISO 10 | 10 | .33 | 8,4  | .33 | 8,4  | .65  | 16,5 |
| 12 x 1.5 | G5432 | PISO 12 | 12 | .41 | 10,4 | .34 | 8,6  | .73  | 18,5 |
| 14 x 1.5 | G5433 | PISO 14 | 12 | .41 | 10,4 | .38 | 9,7  | .81  | 20,6 |
| 18 x 1.5 | G5434 | PISO 18 | 16 | .41 | 10,4 | .44 | 11,2 | .97  | 24,6 |
| 22 x 1.5 | G5435 | PISO 22 | 20 | .41 | 10,4 | .44 | 11,2 | 1.12 | 28,4 |
| 27 x 2   | G5436 | PISO 27 | 24 | .41 | 10,4 | .44 | 11,2 | 1.36 | 34,5 |

\*SAE Threaded Ports feature a slotted 12 point Socket Head.

\*\*NPS threaded hub with shoulder

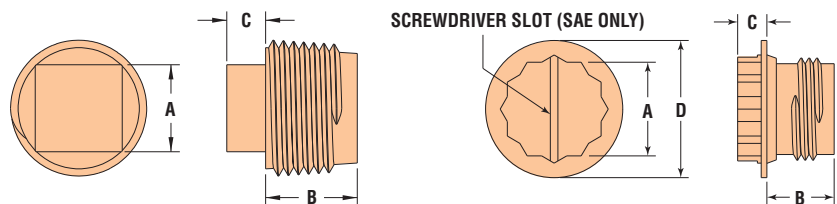

**For SAE and ISO Threaded Ports**

- Provide a dual, positive seal on SAE and ISO straight-threaded ports.
- Integral Sealing Ring seats into the bevel of the threaded opening to prevent oil or fluid leakage.
- Lip on the flange compresses against the mounting hole surface, keeping contaminants from the spot face.
- Suitable for gasketing (optional).
- Slotted, 12-point head for screwdriver (SAE only), socket or wrench tightening.
- Round “socket pattern” Head.

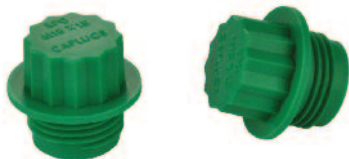

*Quick Specs*

|                   | PNPT, PNPS & PSAE           | PISO                           |
|-------------------|-----------------------------|--------------------------------|
| Material          | HDPE                        | Polypropylene                  |
| Temperature Range | 0°F (-18°C) to 165°F (74°C) | -90°F (-70°C) to 250°F (121°C) |



“Stay Connected” with



Hole Plugs & Venting Solutions

a PennEngineering® Company



## Heyco® Push-In Threaded Plugs - For SAE and NPT Threaded Ports

| THREAD TYPE/SIZE |            | PART NO.        | PART NO.          | DESCRIPTION | PART DIMENSIONS    |      |                     |     |                  |      |
|------------------|------------|-----------------|-------------------|-------------|--------------------|------|---------------------|-----|------------------|------|
| SAE<br>in.       | NPT<br>in. | Black<br>No Tab | Black<br>With Tab |             | A<br>Head Diameter |      | B<br>Overall Height |     | C<br>Bottom Dia. |      |
|                  |            |                 |                   |             | in.                | mm.  | in.                 | mm. | in.              | mm.  |
| 1/4              | -          | 9680            | -                 | TP PI-250   | .40                | 10,2 | .25                 | 6,4 | .21              | 5,3  |
| 5/16             | -          | 9681            | -                 | TP PI-312   | .52                | 13,2 | .24                 | 6,1 | .25              | 6,4  |
| 3/8              | 1/8        | 9682            | 9682T             | TP PI-375   | .59                | 15,0 | .24                 | 6,1 | .32              | 8,1  |
| 7/16             | -          | 9683            | 9683T             | TP PI-437   | .64                | 16,3 | .27                 | 6,9 | .37              | 9,4  |
| 1/2              | 1/4        | 9684            | 9684T             | TP PI-500   | .72                | 18,3 | .27                 | 6,9 | .44              | 11,2 |
| 9/16             | -          | 9685            | -                 | TP PI-562   | .81                | 20,6 | .29                 | 7,4 | .50              | 12,7 |
| 5/8              | 3/8        | 9686            | 9686T             | TP PI-625   | .96                | 24,4 | .29                 | 7,4 | .56              | 14,2 |
| 3/4              | -          | 9687            | 9687T             | TP PI-750   | .95                | 24,1 | .29                 | 7,4 | .68              | 17,3 |
| 7/8              | -          | 9688            | 9688T             | TP PI-875   | 1.15               | 29,2 | .29                 | 7,4 | .80              | 20,3 |

Standard color black.

- Offer the convenience of a push-in plug with the plugging quality of a threaded plug.
- Available with or without convenient Pull Tab for easy removal.

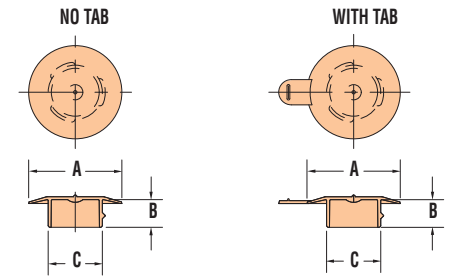

## Heyco® TEMPlugs™ - For NPT Threaded Ports

Temporary Threaded Plugs for In-House Pressure Testing, Handling, and Transport



| NPT<br>THREADED<br>PORT<br>SIZE | PART NO.<br><br>Black | DESCRIPTION | PART DIMENSIONS         |     |                          |     |                     |     |                         |     |
|---------------------------------|-----------------------|-------------|-------------------------|-----|--------------------------|-----|---------------------|-----|-------------------------|-----|
|                                 |                       |             | A<br>Wrenching<br>Flats |     | B<br>Threaded<br>Section |     | C<br>Head<br>Height |     | D<br>Flange<br>Diameter |     |
|                                 |                       |             | in.                     | mm. | in.                      | mm. | in.                 | mm. | in.                     | mm. |

### Square Head - with Flange

|     |       |            |     |      |     |      |     |     |      |      |
|-----|-------|------------|-----|------|-----|------|-----|-----|------|------|
| 1/8 | G5440 | PTNS 1/8-F | .43 | 10,9 | .29 | 7,4  | .19 | 4,8 | .56  | 14,2 |
| 1/4 | G5441 | PTNS 1/4-F | .44 | 11,2 | .35 | 9,0  | .25 | 6,4 | .69  | 17,5 |
| 3/8 | G5442 | PTNS 3/8-F | .44 | 11,2 | .41 | 10,4 | .25 | 6,4 | .81  | 20,6 |
| 1/2 | G5443 | PTNS 1/2-F | .56 | 14,2 | .47 | 11,9 | .25 | 6,4 | 1.00 | 25,4 |
| 3/4 | G5444 | PTNS 3/4-F | .63 | 16,0 | .52 | 13,2 | .25 | 6,4 | 1.25 | 31,8 |

### Square Head - no Flange

|       |       |            |      |      |     |      |     |     |     |     |
|-------|-------|------------|------|------|-----|------|-----|-----|-----|-----|
| 3/4   | G5449 | PTNS 3/4   | .62  | 15,7 | .52 | 13,2 | .25 | 6,4 | n/a | n/a |
| 1     | G5450 | PTNS 1     | .81  | 20,6 | .59 | 15,0 | .25 | 6,4 | n/a | n/a |
| 1-1/4 | G5451 | PTNS 1-1/4 | 1.00 | 25,4 | .83 | 21,1 | .38 | 9,7 |     |     |
| 1-1/2 | G5452 | PTNS 1-1/2 | 1.25 | 31,8 |     |      |     |     |     |     |

### Hex Head

|     |       |          |     |      |     |      |  |  |  |  |
|-----|-------|----------|-----|------|-----|------|--|--|--|--|
| 1/4 | G5455 | PTNH 1/4 | .25 | 6,4  | .31 | 7,9  |  |  |  |  |
| 3/8 | G5456 | PTNH 3/8 | .31 | 7,9  | .38 | 9,7  |  |  |  |  |
| 1/2 | G5457 | PTNH 1/2 | .38 | 9,7  |     |      |  |  |  |  |
| 3/4 | G5458 | PTNH 3/4 | .56 | 14,2 | .50 | 12,7 |  |  |  |  |
| 1   | G5459 | PTNH 1   | .63 | 16,0 | .53 | 13,5 |  |  |  |  |

Standard color black.

- Not intended for permanent applications; commonly used for low-pressure testing and in-plant processing.
- Keep contaminants and moisture from threaded ports.
- Oil and heat resistant up to 250°F.
- Applicable Spec: MIL-C-5501/5, NAS 840.

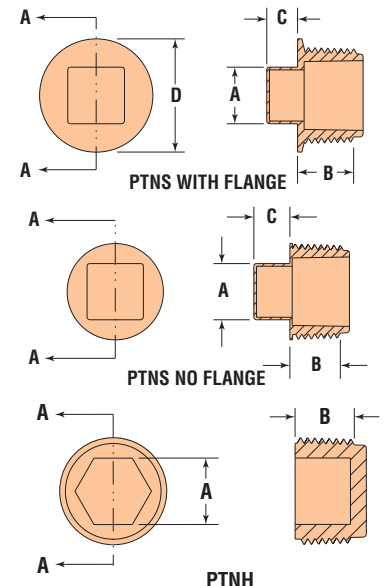

|                   |  |
|-------------------|--|
| Material          | EVA Ethylene Vinyl Acetate (part nos. 9680 & 9681)<br>LDPE Low Density Polyethylene (part nos. 9682 thru 9688T)<br>HDPE High-Density Polyethylene (TEMPlugs) |
| Temperature Range | EVA -98°F (-68°C) to 140°F (60°C)<br>LDPE -94°F (-70°C) to 150°F (66°C)<br>HDPE 0°F (-18°C) to 165°F (74°C)  |

"Stay Connected" with



Hole Plugs & Venting Solutions

a PennEngineering® Company



## HEYCap™ Tapered Caps and Plugs—NPT

For NPT Fitting Hubs and Threaded Mounting Holes

- HEYCaps can be used as either **caps or plugs**.
- Because they are tapered in design and made from highly flexible polyethylene, they not only **fit snugly** but are readily **removable**.
- Applicable Specs: MIL-C-5501/7 (MIL-C-52078), NAS-835.

### CAPS:

- Especially recommended for use on **threaded external NPT fitting hubs**.
- Part dimensions are based on average threaded hub fit. Before ordering in quantity, please sample HEYCaps.
- Recommended Closures: Threaded hubs where Cap dimension B is at least 1% smaller than the hub to be capped. Minimum .020" (0,5 mm).

### PLUGS:

- Especially recommended for use on **threaded internal NPT fittings and mounting holes**.
- Part dimensions are based on average tapped hole fit. Before ordering in quantity, please sample HEYCap Tapered Plugs.
- Recommended Closures: Threaded mounting holes where Plug dimension A is at least 1% larger than the hole to be plugged. Minimum .020" (0,5 mm).

| Fits this NPT Hub or Mounting Hole | PART NO. Red | DESCRIPTION | PART DIMENSIONS          |     |           |     |                 |     |         |     |
|------------------------------------|--------------|-------------|--------------------------|-----|-----------|-----|-----------------|-----|---------|-----|
|                                    |              |             | A - Major Body Diameters |     | B - Minor |     | C Head Diameter |     | D Depth |     |
|                                    |              |             | in.                      | mm. | in.       | mm. | in.             | mm. | in.     | mm. |

### HEYCap Tapered Caps\* for NPT Fitting Hubs - Body Diameters reference Inside

|       |              |             |      |      |      |      |      |      |      |      |
|-------|--------------|-------------|------|------|------|------|------|------|------|------|
| 1/8   | <b>G5014</b> | TCP 49-42†  | .42  | 10,7 | .36  | 9,0  | .63  | 16,0 | .38  | 9,7  |
| 1/4   | <b>G5020</b> | TCP 61-55   | .55  | 13,8 | .47  | 11,9 | .75  | 19,1 | .44  | 11,2 |
| 3/8   | <b>G5027</b> | TCP 76-69   | .69  | 17,6 | .61  | 15,6 | .88  | 22,4 | .50  | 12,7 |
| 1/2   | <b>G5035</b> | TCP 91-85   | .85  | 21,6 | .74  | 18,8 | 1.06 | 26,9 | .63  | 16,0 |
| 3/4   | <b>G5047</b> | TCP 115-108 | 1.08 | 27,5 | .93  | 23,7 | 1.31 | 33,3 | .75  | 19,1 |
| 1     | <b>G5057</b> | TCP 136-130 | 1.30 | 33,0 | 1.17 | 29,8 | 1.50 | 38,1 | .81  | 20,6 |
| 1-1/4 | <b>G5071</b> | TCP 168-162 | 1.62 | 41,1 | 1.50 | 38,0 | 1.88 | 47,8 | .75  | 19,1 |
| 1-1/2 | <b>G5080</b> | TCP 195-189 | 1.89 | 48,0 | 1.72 | 43,6 | 2.13 | 54,1 |      |      |
| 2     | <b>G5096</b> | TCP 246-240 | 2.40 | 61,0 | 2.24 | 56,8 | 2.63 | 66,8 | 1.00 | 25,4 |
| 2-1/2 | <b>G5110</b> | TCP 299-295 | 2.95 | 74,9 | 2.69 | 68,2 | 3.13 | 79,5 |      |      |
| 3     | <b>G5116</b> | TCP 356-349 | 3.49 | 88,7 | 3.20 | 81,3 | 3.69 | 93,7 | 1.13 | 28,7 |

### HEYCap Tapered Plugs\*\* for NPT Threaded Mounting Holes - Body Diameters reference Outside

|       |              |             |      |      |      |      |      |      |     |      |
|-------|--------------|-------------|------|------|------|------|------|------|-----|------|
| 1/8   | <b>G5011</b> | TCP 40-33   | .40  | 10,1 | .33  | 8,4  | .53  | 13,5 | .38 | 9,7  |
| 1/4   | <b>G5014</b> | TCP 49-42†  | .49  | 12,4 | .42  | 10,7 | .63  | 16,0 |     |      |
| 3/8   | <b>G5022</b> | TCP 63-57   | .63  | 16,0 | .55  | 14,0 | .75  | 19,1 | .47 | 11,9 |
| 1/2   | <b>G5029</b> | TCP 79-73   | .79  | 20,1 | .69  | 17,5 | .94  | 23,9 | .56 | 14,2 |
| 3/4   | <b>G5040</b> | TCP 104-98  | 1.04 | 26,4 | .92  | 23,4 | 1.16 | 29,5 | .69 | 17,5 |
| 1     | <b>G5048</b> | TCP 122-115 | 1.22 | 31,0 | 1.09 | 27,7 | 1.41 | 35,8 | .75 | 19,1 |
| 1-1/4 | <b>G5068</b> | TCP 160-154 | 1.60 | 40,6 | 1.51 | 38,4 | 1.75 | 44,5 | .50 | 12,7 |
| 1-1/2 | <b>G5075</b> | TCP 181-175 | 1.81 | 46,0 | 1.78 | 45,2 | 2.00 | 50,8 | .38 | 9,7  |
| 2     | <b>G5090</b> | TCP 226-220 | 2.26 | 57,4 | 2.23 | 56,6 | 2.50 | 63,5 | .50 | 12,7 |
| 2-1/2 | <b>G5106</b> | TCP 279-273 | 2.79 | 70,9 | 2.64 | 67,1 | 2.94 | 74,7 |     |      |
| 3     | <b>G5115</b> | TCP 346-338 | 3.46 | 87,9 | 3.33 | 84,6 | 3.63 | 92,2 | .75 | 19,1 |

\*May also be used as Plugs: to determine Outside Diameters, add approximately .06" (1,5 mm) to Inside Diameter dimensions.

\*\*May also be used as Caps: to determine Inside Diameters, subtract approximately .06" (1,5 mm) from Outside Diameter dimensions.

†Part No. **G5014** functions as a Cap for NPT 1/8" Hubs and a Plug for NPT 1/4" Hubs. Standard color red.



TAPERED CAP

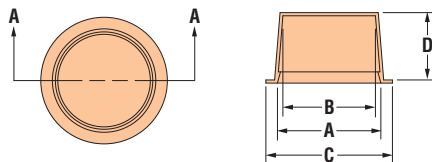

TAPERED PLUG

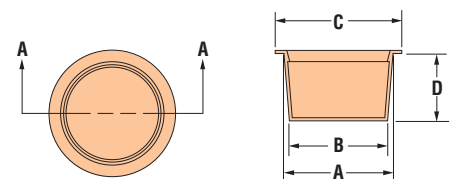

Quick  
Specs

|                   |  |
|-------------------|--|
| Material          | LDPE   |
| Temperature Range | Standard Color: Red<br>-94°F (-70°C) to 150°F (66°C) |



## HEYCap™ Tapered Caps and Plugs—SAE

For SAE Fitting Hubs and Threaded Mounting Holes

| Fits this SAE Hub or Mounting Hole   | PART NO. Red | DESCRIPTION | PART DIMENSIONS          |      |           |      |                 |      |         |      |
|--|--------------|-------------|--------------------------|------|-----------|------|-----------------|------|---------|------|
|  |              |             | A - Major Body Diameters |      | B - Minor |      | C Head Diameter |      | D Depth |      |
|  |              |             | in.                      | mm.  | in.       | mm.  | in.             | mm.  | in.     | mm.  |
| <b>HEYCap Tapered Caps*</b> for SAE Fitting Hubs - Body Diameters reference Inside               |              |             |                          |      |           |      |                 |      |         |      |
| 1/8  | G5009        | TCP 37-30†  | .30                      | 7,7  | .24       | 6,0  | .50             | 12,7 |         |      |
| 3/16   | G5013        | TCP 46-39   | .39                      | 10,0 | .33       | 8,3  | .59             | 15,0 | .38     | 9,7  |
| 1/4  | G5015        | TCP 51-45   | .45                      | 11,5 | .39       | 9,8  | .66             | 16,8 |         |      |
| 5/16   | G5022        | TCP 63-57   | .57                      | 14,4 | .49       | 12,4 | .75             | 19,1 | .47     | 11,9 |
| 3/8  | G5023        | TCP 67-61   | .61                      | 15,4 | .52       | 13,2 | .81             | 20,6 | .50     | 12,7 |
| 1/2  | G5031        | TCP 82-76   | .76                      | 19,3 | .66       | 16,8 | .97             | 24,6 | .57     | 14,2 |
| 5/8  | G5036        | TCP 93-87   | .87                      | 22,0 | .75       | 19,1 | 1.09            | 27,7 | .63     | 16,0 |
| 3/4  | G5047        | TCP 115-108 | 1.08                     | 27,5 | .93       | 23,7 | 1.31            | 33,3 | .75     | 19,1 |
| 1  | G5057        | TCP 136-130 | 1.30                     | 33,0 | 1.17      | 29,8 | 1.50            | 38,1 | .81     | 20,6 |
| 1-1/4  | G5071        | TCP 168-162 | 1.62                     | 41,1 | 1.50      | 38,0 | 1.88            | 47,8 | .75     | 19,1 |
| 1-1/2  | G5080        | TCP 195-189 | 1.89                     | 48,0 | 1.72      | 43,6 | 2.13            | 54,1 | 1.00    | 25,4 |
| 1-3/4  | G5092        | TCP 231-225 | 2.25                     | 57,2 | 2.07      | 52,7 | 2.56            | 65,0 |         |      |
| 2  | G5097        | TCP 260-254 | 2.54                     | 64,5 | 2.33      | 59,3 | 2.81            | 71,4 | 1.03    | 26,2 |
| <b>HEYCap Tapered Plugs**</b> for SAE Threaded Mounting Holes - Body Diameters reference Outside |              |             |                          |      |           |      |                 |      |         |      |
| 1/8  | G5007        | TCP 30-24   | .30                      | 7,7  | .24       | 6,0  | .44             | 11,2 |         |      |
| 3/16   | G5009        | TCP 37-30†  | .37                      | 9,3  | .30       | 7,6  | .50             | 12,7 |         |      |
| 1/4  | G5012        | TCP 43-37   | .43                      | 10,8 | .36       | 9,2  | .56             | 14,2 | .38     | 9,7  |
| 5/16   | G5014        | TCP 49-42   | .49                      | 12,3 | .42       | 10,6 | .63             | 16,0 |         |      |
| 3/8††  | G5016        | TCP 55-49   | .55                      | 13,9 | .47       | 12,0 | .69             | 17,5 | .44     | 11,2 |
|  | G5020        | TCP 61-55   | .61                      | 15,4 | .53       | 13,5 | .75             | 19,1 |         |      |
| 1/2  | G5026        | TCP 73-66   | .73                      | 18,5 | .64       | 16,3 | .88             | 22,4 | .50     | 12,7 |
| 5/8  | G5033        | TCP 85-79   | .85                      | 21,5 | .75       | 19,1 | 1.00            | 25,9 | .56     | 9,9  |
| 3/4  | G5040        | TCP 104-98  | 1.04                     | 26,4 | .92       | 23,2 | 1.16            | 29,5 | .69     | 17,5 |
| 1  | G5049        | TCP 128-122 | 1.28                     | 32,6 | 1.18      | 29,8 | 1.44            | 36,6 | .63     | 16,0 |
| 1-1/4  | G5068        | TCP 160-154 | 1.60                     | 40,6 | 1.51      | 38,4 | 1.75            | 44,5 | .50     | 12,7 |
| 1-1/2  | G5077        | TCP 188-182 | 1.88                     | 47,8 | 1.75      | 44,5 | 2.00            | 50,8 | .75     | 19,1 |
| 1-3/4  | G5089        | TCP 224-218 | 2.24                     | 57,0 | 2.07      | 52,5 | 2.44            | 62,0 | 1.00    | 25,4 |
| 2  | G5096        | TCP 246-240 | 2.46                     | 62,6 | 2.30      | 58,4 | 2.63            | 66,8 | 1.00    | 25,4 |

\*May also be used as Plugs: to determine Outside Diameters, add approximately .06" (1,5 mm) to Inside Diameter dimensions.

\*\*May also be used as Caps: to determine Inside Diameters, subtract approximately .06" (1,5mm) from Outside Diameter dimensions.

†Part No. G5009 functions as a Cap for SAE 1/8" Hubs and a Plug for SAE 3/16" Hubs.

††Use Part No. G5016 for SAE 9/16-18 thread and Part No. G5020 for SAE 5/8-18 thread Standard color red.

- HEYCaps can be used as either **caps or plugs**.
- Because they are tapered in design and made from highly flexible polyethylene, they not only **fit snugly** but are readily **removable**.
- Applicable Specs: MIL-C-5501/7 (MIL-C-52078), NAS-835.

### CAPS:

- Especially recommended for use on **threaded external SAE and MIL Std.-type** tube and hydraulic fittings.
- Part dimensions are based on average threaded hub fit. Before ordering in quantity, please sample HEYCaps.
- Recommended Closures: Threaded hubs where Cap dimension B is at least 1% smaller than the hub to be capped. Minimum .020" (0,5 mm).

### PLUGS:

- Especially recommended for use on **threaded internal SAE and MIL Std.-type** tube and hydraulic fittings.
- Part dimensions are based on average tapped hole fit. Before ordering in quantity, please sample HEYCap Tapered Plugs.
- Recommended Closures: Threaded mounting holes where Plug dimension A is at least 1% larger than the hole to be plugged. Minimum .020" (0,5 mm).
- See schematic on page 6-47.



Quick Specs

Material LDPE  
Standard Color: Red  
Temperature Range -94°F (-70°C) to 150°F (66°C)

“Stay Connected” with



Hole Plugs & Venting Solutions

a PennEngineering® Company



- Close unneeded sheet metal panel holes in equipment such as automobile bodies, tanks, refrigeration units, etc.
- Recessed button head style (SMP R).
- Flush button head style (SMP F).
- Retaining bead snaps easily into place.
- For easier to install Sheet Metal Plugs made from flexible Santoprene, see Heyco Metric Ergonomic Plugs on page 6-33.

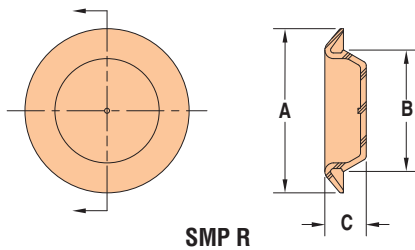

SMP R

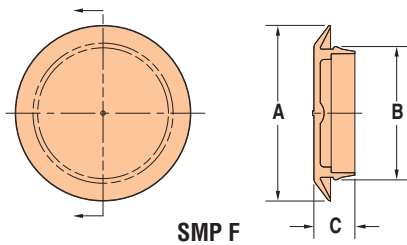

SMP F

## Heyco® LDPE Sheet Metal Plugs

For Panel Thicknesses from .02" (0,5 mm) to .18" (4,6 mm)

Mounting Hole Diameter Range: .18" (4,6 mm) to 3.00" (76,2 mm)

| PANEL DIMENSIONS   |           |                              |           | PART NO. | DESCRIPTION   | PART DIMENSIONS |      |                 |      |     |                |     |     |     |      |
|--|-----------|------------------------------|-----------|----------|---------------|-----------------|------|-----------------|------|-----|----------------|-----|-----|-----|------|
| Thickness Range  |           | Mounting Hole Diameter Range |           |          |               | A               |      | B               |      | C   |                |     |     |     |      |
| in.  | mm.       | in.                          | mm.       | Black    | Head Diameter | in.             | mm.  | Bottom Diameter | in.  | mm. | Overall Height | in. | mm. |     |      |
| <b>Recessed Head - for Panel Thicknesses from .02" (0,5 mm) to .18" (4,6 mm)</b> |           |                              |           |          |               |                 |      |                 |      |     |                |     |     |     |      |
| .02-.10  | 0,51-2,54 | .37-.39                      | 9,4-9,9   | 9610     | SMP R-375     | .75             | 19,1 | .41             | 10,4 | .31 | 7,9            |     |     |     |      |
| .02-.07  | 0,51-1,78 | .50-.52                      | 12,7-13,2 | 9611     | SMP R-500     | .85             | 21,6 | .55             | 14,0 | .29 | 7,4            |     |     |     |      |
| .02-.14  | 0,51-3,56 | .73-.76                      | 18,5-19,3 | 9614     | SMP R-750     | 1.16            | 29,5 | .79             | 20,1 | .34 | 8,6            |     |     |     |      |
| .02-.07  | 0,51-1,78 | .79-.82                      | 20,1-20,8 | 9615     | SMP R-812     | 1.15            | 29,2 | .85             | 21,6 | .29 | 7,4            |     |     |     |      |
| .02-.10  | 0,51-2,54 | .87-.90                      | 22,1-22,9 | 9616     | SMP R-875     | 1.23            | 31,2 | .93             | 23,6 | .35 | 8,9            |     |     |     |      |
|  |           | .99-1.02                     | 25,2-25,9 | 9618     | SMP R-1000    | 1.35            | 34,3 | 1.05            | 26,7 |     |                |     |     |     |      |
|  |           | 1.04-1.07                    | 26,4-27,2 | 9619     | SMP R-1062    | 1.40            | 35,6 | 1.10            | 27,9 |     |                |     |     |     |      |
|  |           | 1.09-1.12                    | 27,7-28,5 | 9620     | SMP R-1093    | 1.47            | 37,3 | 1.16            | 29,5 |     |                |     |     |     |      |
| .02-.18  | 0,51-4,57 | 1.10-1.15                    | 27,9-29,2 | 9621     | SMP R-1125    | 1.53            | 38,9 | 1.18            | 30,0 | .43 | 10,9           |     |     |     |      |
| .01-.10  | 0,25-2,54 | 1.23-1.27                    | 31,2-32,3 | 9622     | SMP R-1250    | 1.60            | 40,6 | 1.30            | 33,0 | .35 | 8,9            |     |     |     |      |
|  |           | 1.30-1.34                    | 33,0-34,0 | 9623     | SMP R-1312    | 1.67            | 42,4 | 1.36            | 34,5 |     |                |     |     |     |      |
| .02-.10  | 0,51-2,54 | 1.36-1.40                    | 34,6-35,6 | 9624     | SMP R-1375    | 1.73            | 43,9 | 1.43            | 36,3 |     |                |     |     |     |      |
|  |           | 1.48-1.52                    | 37,6-38,6 | 9625     | SMP R-1500    | 1.85            | 47,0 | 1.55            | 39,4 |     |                |     |     |     |      |
| .03-.10  | 0,76-2,54 | 1.59-1.65                    | 40,4-41,9 | 9627     | SMP R-1625    | 2.00            | 50,8 | 1.68            | 42,7 | .36 | 9,1            |     |     |     |      |
| .02-.10  | 0,51-2,54 | 1.75                         | 44,5      | 9628     | SMP R-1750    | 2.13            | 54,1 | 1.80            | 45,7 | .35 | 8,9            |     |     |     |      |
|  |           | 1.85-1.90                    | 47,0-48,3 | 9631     | SMP R-1875    | 2.24            | 56,9 | 1.93            | 49,0 |     |                |     |     |     |      |
| .02-.10  | 0,51-2,54 | 1.97-2.02                    | 50,0-51,3 | 9632     | SMP R-2000    | 2.35            | 59,7 | 2.05            | 52,1 | .36 | 9,1            |     |     |     |      |
|  |           | 2.50                         | 63,5      | 9633     | SMP R-2.5     | 3.00            | 76,2 | 2.57            | 65,3 |     |                | .38 | 9,7 |     |      |
|  |           | 3.00                         | 76,2      | 9635     | SMP R-3.0     | 3.56            | 90,4 | 3.06            | 77,7 |     |                |     |     | .41 | 10,4 |

### Flush Head - for Panel Thicknesses from .02" (0,5 mm) to .11" (2,8 mm)

|         |           |           |           |      |            |      |      |      |      |     |      |  |  |
|---------|-----------|-----------|-----------|------|------------|------|------|------|------|-----|------|--|--|
| .02-.04 | 0,51-1,02 | .18-.19   | 4,6-4,9   | 9640 | SMP F-M5*  | .39  | 9,9  | .21  | 5,3  | .21 | 5,3  |  |  |
| .02-.06 | 0,51-1,52 | .23-.24   | 5,8-6,1   | 9641 | SMP F-M6*  | .50  | 12,7 | .29  | 7,4  | .45 | 11,4 |  |  |
| .02-.07 | 0,51-1,78 | .24-.25   | 6,1-6,4   | 9642 | SMP F-250* | .50  | 12,7 | .28  | 7,1  | .21 | 5,3  |  |  |
| .02-.05 | 0,51-1,27 | .37-.38   | 9,4-9,7   | 9644 | SMP F-375  | .75  | 19,1 | .41  | 10,4 | .19 | 4,8  |  |  |
| .03-.06 | 0,76-1,52 | .43-.45   | 10,9-11,4 | 9646 | SMP F-437  | .69  | 17,5 | .47  | 11,9 | .22 | 5,6  |  |  |
| .03-.08 | 0,76-2,03 | .49-.51   | 12,5-13,0 | 9647 | SMP F-500  | .86  | 21,8 | .54  | 13,7 | .25 | 6,4  |  |  |
|         |           | .55-.56   | 14,0-14,2 | 9648 | SMP F-562  | .87  | 22,1 | .60  | 15,2 |     |      |  |  |
| .06-.08 | 1,52-2,03 | .62       | 15,7      | 9649 | SMP F-625  | .81  | 20,6 | .67  | 17,0 |     |      |  |  |
| .03-.08 | 0,76-2,03 | .68-.70   | 17,3-17,8 | 9650 | SMP F-687  | 1.01 | 25,7 | .73  | 18,5 |     |      |  |  |
| .05-.11 | 1,27-2,79 | .73-.76   | 18,5-19,3 | 9651 | SMP F-750  | 1.01 | 25,7 | .79  | 20,1 | .29 | 7,4  |  |  |
| .03-.08 | 0,76-2,03 | .86-.88   | 21,8-22,4 | 9654 | SMP F-875  | 1.16 | 29,5 | .91  | 23,1 | .25 | 6,4  |  |  |
|         |           | .92-.95   | 23,4-24,1 | 9656 | SMP F-937  | 1.31 | 33,3 | .98  | 24,9 |     |      |  |  |
|         |           | 1.00      | 25,4      | 9657 | SMP F-1000 | 1.38 | 35,1 | 1.04 | 26,4 |     |      |  |  |
| .02-.18 | 0,51-4,57 | 1.10-1.15 | 27,9-29,2 | 9660 | SMP F-1125 | 1.53 | 38,9 | 1.18 | 30,0 | .43 | 10,9 |  |  |
| .03-.08 | 0,76-2,03 | 1.16-1.20 | 29,5-30,5 | 9661 | SMP F-1187 | 1.56 | 39,6 | 1.22 | 31,0 | .25 | 6,4  |  |  |
|         |           | 1.25      | 31,8      | 9663 | SMP F-1250 | 1.62 | 41,1 | 1.29 | 32,8 |     |      |  |  |
|         |           | 1.29-1.33 | 32,8-33,8 | 9664 | SMP F-1312 | 1.68 | 42,7 | 1.36 | 34,6 |     |      |  |  |
|         |           | 1.50      | 38,1      | 9665 | SMP F-1500 | 1.88 | 47,8 | 1.54 | 39,1 |     |      |  |  |
|         |           | 1.75      | 44,5      | 9666 | SMP F-1750 | 2.12 | 53,8 | 1.79 | 45,5 |     |      |  |  |
|         |           | 1.98-2.01 | 50,3-51,1 | 9667 | SMP F-2000 | 2.36 | 59,9 | 2.04 | 51,8 |     |      |  |  |
|         |           | 2.50      | 63,5      | 9669 | SMP F-2.5  | 3.00 | 76,2 | 2.56 | 65,0 |     |      |  |  |
| 3.00    | 76,2      | 9671      | SMP F-3.0 | 3.36 | 85,3       | 3.06 | 77,7 |      |      |     |      |  |  |

Standard color black.  
\* Molded from EVA.

Quick  
Specs

Material EVA\* and LDPE  
Temperature Range -98°F (-68°C) to 140°F (60°C) (EVA)  
-94°F (-70°C) to 150°F (66°C) (LDPE)

# HEYCaps™ and Plugs for Round Tubing

## CRT Series Caps – Clearance Fit



| TUBE A<br>Outside Dia. |      | PART NO.<br>Black | DESCRIPTION | HEYCap B<br>Height |      |
|------------------------|------|-------------------|-------------|--------------------|------|
| in.                    | mm.  |                   |             | in.                | mm.  |
| <b>Standard Duty</b>   |      |                   |             |                    |      |
| .25                    | 6,4  | G5200             | CRT 25      | .46                | 11,7 |
| .38                    | 9,5  | G5201             | CRT 38      |                    |      |
| .50                    | 12,7 | G5202             | CRT 50      | .59                | 15,0 |
| .63                    | 15,9 | G5203             | CRT 63      |                    |      |
| .75                    | 19,1 | G5204             | CRT 75      | .71                | 18,0 |
| .88                    | 22,2 | G5205             | CRT 88      |                    |      |
| 1.00                   | 25,4 | G5207             | CRT 100     | .85                | 21,6 |
| 1.13                   | 28,6 | G5208             | CRT 113     |                    |      |
| 1.25                   | 31,8 | G5209             | CRT 125     | .98                | 24,9 |
| 1.50                   | 38,1 | G5210             | CRT 150     |                    |      |
| 1.75                   | 44,5 | G5211             | CRT 175     | 1.10               | 27,9 |
| <b>Heavy Duty</b>      |      |                   |             |                    |      |
|                        |      |                   |             | Depth              |      |
| .75                    | 19,1 | G5212             | CRT 75H     | .50                | 12,7 |
| .88                    | 22,2 | G5213             | CRT 88H     |                    |      |
| 1.00                   | 25,4 | G5214             | CRT 100H    | .62                | 15,8 |
| 1.13                   | 28,6 | G5215             | CRT 113H    |                    |      |
| 1.25                   | 31,8 | G5216             | CRT 125H    |                    |      |

Standard color black.

## PRT Series Plugs – Ribbed Fit

| TUBE DIMENSIONS       |         |               |                  |         | PART NO.<br>Black | DESCRIPTION | PART DIMENSIONS |      |     |      |
|-----------------------|---------|---------------|------------------|---------|-------------------|-------------|-----------------|------|-----|------|
| Inside Diameter Range |         | Typical Gauge | A                |         |                   |             | B               |      | in. | mm.  |
| Minimum               | Maximum |               | Outside Diameter | Depth   |                   |             | in.             | mm.  |     |      |
| in.                   | mm.     | in.           | mm.              |         |                   |             |                 |      |     |      |
| .31                   | 7,9     | .33           | 8,4              | 13 - 14 | G5220             | PRT 50-13   | .50             | 12,7 | .45 | 11,4 |
| .37                   | 9,4     | .43           | 10,9             | 16 - 20 | G5221             | PRT 50-16   |                 |      |     |      |
| .46                   | 11,7    | .56           | 14,2             | 14 - 20 | G5223             | PRT 63-14   | .63             | 15,9 | .44 | 11,2 |
| .58                   | 14,7    | .68           | 17,3             | 14 - 20 | G5224             | PRT 75-14   |                 |      |     |      |
| .61                   | 15,5    | .71           | 18,1             | 10 - 14 | G5225             | PRT 88-10   | .88             | 22,2 | .52 | 13,2 |
| .71                   | 18,0    | .91           | 23,1             | 14 - 20 | G5226             | PRT 88-14   |                 |      |     |      |
| .73                   | 18,5    | .83           | 21,1             | 10 - 14 | G5227             | PRT 100-10  | 1.00            | 25,4 | .50 | 12,7 |
| .83                   | 21,0    | .93           | 23,6             | 14 - 20 | G5228             | PRT 100-14  |                 |      |     |      |
| .96                   | 23,4    | 1.06          | 26,9             | 14 - 20 | G5229             | PRT 113-14  | 1.13            | 28,6 | .50 | 12,7 |
| .98                   | 24,9    | 1.08          | 27,4             | 10 - 14 | G5230             | PRT 125-10  |                 |      |     |      |
| 1.08                  | 27,4    | 1.18          | 30,0             | 14 - 20 | G5231             | PRT 125-14  | 1.25            | 31,8 | .52 | 13,2 |
| 1.21                  | 30,7    | 1.31          | 33,3             | 14 - 20 | G5232             | PRT 138-14  |                 |      |     |      |
| 1.17                  | 29,7    | 1.28          | 32,5             | 8 - 12  | G5233             | PRT 150-08  | 1.50            | 38,1 | .52 | 13,2 |
| 1.23                  | 21,2    | 1.33          | 33,8             | 10 - 14 | G5234             | PRT 150-10  |                 |      |     |      |
| 1.33                  | 33,8    | 1.43          | 36,3             | 14 - 20 | G5235             | PRT 150-14  | 1.75            | 44,5 | .59 | 15,0 |
| 1.36                  | 34,5    | 1.46          | 37,1             | 10 - 14 | G5236             | PRT 163-10  |                 |      |     |      |
| 1.46                  | 37,0    | 1.56          | 39,6             | 14 - 20 | G5237             | PRT 163-14  | 1.63            | 41,3 | .50 | 12,7 |
| 1.48                  | 37,6    | 1.58          | 40,1             | 10 - 14 | G5238             | PRT 175-10  |                 |      |     |      |
| 1.58                  | 40,1    | 1.68          | 42,7             | 14 - 20 | G5239             | PRT 175-14  | 1.95            | 49,5 | .67 | 17,0 |
| 1.73                  | 43,9    | 1.83          | 46,5             | 10 - 14 | G5241             | PRT 200-10  |                 |      |     |      |
| 1.83                  | 46,5    | 1.93          | 49,0             | 14 - 20 | G5242             | PRT 200-14  | 2.00            | 50,8 | .66 | 16,8 |
| 1.86                  | 47,2    | 2.00          | 50,8             | 10 - 14 | G5243             | PRT 213-10  |                 |      |     |      |
| 1.98                  | 50,3    | 2.08          | 52,8             | 10 - 14 | G5244             | PRT 225-10  | 2.25            | 57,2 | .69 | 17,5 |
| 2.08                  | 52,8    | 2.18          | 53,4             | 14 - 20 | G5245             | PRT 225-14  |                 |      |     |      |
| 2.11                  | 53,6    | 2.21          | 56,1             | 10 - 14 | G5246             | PRT 238-10  | 2.38            | 60,3 | .66 | 16,8 |
| 2.17                  | 55,1    | 2.28          | 57,9             | 8 - 12  | G5247             | PRT 250-08  |                 |      |     |      |
| 2.43                  | 61,7    | 2.47          | 62,7             | 14 - 20 | G5248             | PRT 250-14  | 2.50            | 63,5 | .69 | 17,5 |

Standard color black.

|                   |                               |
|-------------------|-------------------------------|
| Material          | LDPE                          |
| Temperature Range | -94°F (-70°C) to 150°F (66°C) |

## CRT – Standard Duty

- HEYCaps Series CRT Caps for Round Tubing make **economical, attractive glides** for household and patio furniture; office tables, chairs and equipment; utility carts and exercise equipment.
- As **finishing caps** for both tubing and rods, they cover any scratches, burrs or distortions that may result from cutting operations.
- Provide protection against injury from sharp rod and tubing edges.
- See pages 6-51 and 6-52 for Heyco Plugs for Square and Rectangular Tubing.

## CRT – Heavy Duty

- Heavy Duty Caps **finish the ends of round tubing** on numerous products such as furniture, lawn and garden equipment, tools and appliances.
- **Thick wall construction** makes them ideal for threaded connections where extra protection is required.
- Designed for **easy installation**.
- **Seat with a firm grip** that prevents accidental removal.

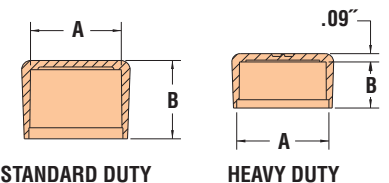

## PRT Series

- With durable construction and **excellent gliding edges**, Heyco PRT Series Plugs for Round Tubing may be used on a wide range of metal furniture, appliances, and similar items.
- **Tapered rib design** ensures a secure fit.
- A **thick, impact and abrasion resistant base** makes PNT Series Plugs ideal tubing closures for products subject to heavy-duty service or exposure to adverse environments.
- Not subject to rust or corrosion.
- For larger diameter sizes, please consult Heyco.

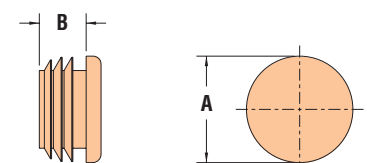



- Heyco Series PST Plugs for Square Tubing **finish raw tubing ends** with a clean finish.
- Sized for different gauges, **fit flush with tubing sides.**
- **Keep dirt and moisture out** of sensitive areas.
- All PST Series Plugs are **.50" (12,7 mm) in depth.**
- **Protect against injury** from sharp tubing edges.
- See page 6-50 for HEYCaps and Plugs for Round Tubing
- See page 6-52 for Heyco Plugs for Rectangular Tubing.

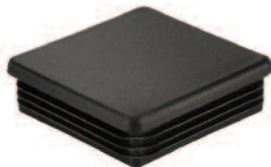
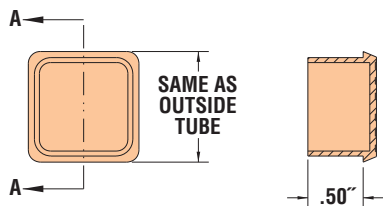

- Heyco PSTR Series Plugs feature **externally tapered ribs** designed to fit a wide range of tubing gauges while accommodating any dimensional fluctuations within the tubing.
- Exterior ribs provide a **sure grip inside the tubing**, without the unsightly plastic shavings found on many straight wall glide installations.
- Not subject to rust or corrosion.
- For larger sizes, please consult Heyco.

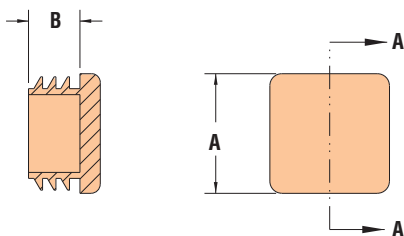

## Heyco® Plugs for Square Tubing

### PST Series - Clearance Fit

| TUBE DIMENSIONS   |      |                  |      | Typical Gauge | PART NO. Black | DESCRIPTION |
|-------------------|------|------------------|------|---------------|----------------|-------------|
| Outside Dimension |      | Inside Dimension |      |               |                |             |
| in.               | mm.  | in.              | mm.  |               |                |             |
| .50               | 12,7 | .37              | 9,4  | 16            | <b>G5260</b>   | PST 50-16   |
| .75               | 19,1 | .62              | 15,7 | 16            | <b>G5261</b>   | PST 75-16   |
| 1.00              | 25,4 | .76              | 19,3 | 11            | <b>G5262</b>   | PST 100-11  |
|                   |      | .83              | 21,1 | 14            | <b>G5263</b>   | PST 100-14  |
|                   |      | .87              | 22,1 | 16            | <b>G5264</b>   | PST 100-16  |
|                   |      | .90              | 22,9 | 18            | <b>G5265</b>   | PST 100-18  |
|                   |      | .93              | 23,6 | 20            | <b>G5266</b>   | PST 100-20  |
| 1.25              | 31,8 | 1.01             | 25,7 | 11            | <b>G5267</b>   | PST 125-11  |
|                   |      | 1.08             | 27,4 | 14            | <b>G5268</b>   | PST 125-14  |
|                   |      | 1.12             | 28,4 | 16            | <b>G5269</b>   | PST 125-16  |
| 1.50              | 38,1 | 1.26             | 32,0 | 11            | <b>G5270</b>   | PST 150-11  |
|                   |      | 1.33             | 33,9 | 14            | <b>G5271</b>   | PST 150-14  |
|                   |      | 1.37             | 34,8 | 16            | <b>G5272</b>   | PST 150-16  |
| 2.00              | 50,8 | 1.76             | 44,7 | 11            | <b>G5273</b>   | PST 200-11  |
|                   |      | 1.83             | 46,6 | 14            | <b>G5274</b>   | PST 200-14  |
|                   |      | 1.87             | 47,5 | 16            | <b>G5275</b>   | PST 200-16  |

Standard color black.

### PSTR Series - Ribbed Fit

| TUBE DIMENSIONS                |      |         |      |               | PART NO. Black | DESCRIPTION  | PART DIMENSIONS     |      |         |      |
|--------------------------------|------|---------|------|---------------|----------------|--------------|---------------------|------|---------|------|
| Inside Dimension Range Minimum |      | Maximum |      | Typical Gauge |                |              | A Outside Dimension |      | B Depth |      |
| in.                            | mm.  | in.     | mm.  |               |                | in.          | mm.                 | in.  | mm.     |      |
| .37                            | 9,4  | .40     | 10,2 | 16 - 18       | <b>G5280</b>   | PST R-50-16  | .50                 | 12,7 | .44     | 11,2 |
| .46                            | 11,8 | .56     | 14,2 | 14 - 20       | <b>G5281</b>   | PST R-63-14  | .63                 | 15,9 | .43     | 10,9 |
| .48                            | 12,2 | .58     | 14,8 | 10 - 14       | <b>G5282</b>   | PST R-75-10  | .75                 | 19,1 |         |      |
| .58                            | 14,8 | .68     | 17,3 | 14 - 20       | <b>G5283</b>   | PST R-75-14  |                     |      |         |      |
| .71                            | 18,1 | .81     | 20,6 | 14 - 20       | <b>G5284</b>   | PST R-88-14  | .88                 | 22,2 |         |      |
| .73                            | 18,6 | .83     | 21,2 | 10 - 14       | <b>G5285</b>   | PST R-100-10 | 1.00                | 25,4 |         |      |
| .83                            | 21,2 | .93     | 23,6 | 14 - 20       | <b>G5287</b>   | PST R-100-14 |                     |      |         |      |
| .96                            | 24,5 | 1.06    | 26,9 | 14 - 20       | <b>G5289</b>   | PST R-113-14 | 1.13                | 28,6 | .49     | 12,4 |
| .98                            | 24,9 | 1.08    | 27,5 | 10 - 14       | <b>G5290</b>   | PST R-125-10 | 1.25                | 31,8 | .52     | 13,2 |
| 1.08                           | 27,5 | 1.18    | 30,0 | 14 - 20       | <b>G5291</b>   | PST R-125-14 |                     |      |         |      |
| 1.11                           | 28,2 | 1.21    | 30,8 | 10 - 14       | <b>G5292</b>   | PST R-138-10 | 1.38                | 34,9 |         |      |
| 1.21                           | 30,8 | 1.31    | 33,3 | 14 - 20       | <b>G5293</b>   | PST R-138-14 |                     |      |         |      |
| 1.23                           | 31,3 | 1.33    | 33,9 | 10 - 14       | <b>G5294</b>   | PST R-150-10 | 1.50                | 38,1 |         |      |
| 1.33                           | 33,9 | 1.43    | 36,3 | 14 - 20       | <b>G5295</b>   | PST R-150-14 |                     |      |         |      |
| 1.48                           | 37,6 | 1.58    | 40,2 | 10 - 14       | <b>G5296</b>   | PST R-170-10 | 1.75                | 44,5 |         |      |
| 1.58                           | 40,2 | 1.68    | 42,7 | 14 - 20       | <b>G5297</b>   | PST R-170-14 |                     |      |         |      |
| 1.52                           | 38,7 | 1.67    | 42,4 | 4 - 8         | <b>G5298</b>   | PST R-200-04 | 2.00                | 50,8 |         |      |
| 1.73                           | 44,0 | 1.83    | 46,6 | 10 - 14       | <b>G5299</b>   | PST R-200-10 |                     |      |         |      |
| 1.83                           | 46,6 | 1.93    | 49,0 | 14 - 20       | <b>G5300</b>   | PST R-200-14 | 2.50                | 63,5 | .56     | 14,2 |
| 1.98                           | 50,3 | 2.08    | 52,9 | 10 - 14       | <b>G5301</b>   | PST R-225-10 |                     |      |         |      |
| 2.09                           | 53,2 | 2.23    | 56,7 | 6 - 10        | <b>G5302</b>   | PST R-250-06 |                     |      |         |      |
| 2.23                           | 56,7 | 2.33    | 59,3 | 10 - 14       | <b>G5303</b>   | PST R-250-10 | 2.50                | 63,5 | .50     | 12,7 |
| 2.37                           | 60,2 | 2.45    | 62,2 | 16 - 23       | <b>G5304</b>   | PST R-250-16 |                     |      |         |      |

Standard color black.

Material LDPE  
 Temperature Range -94°F (-70°C) to 150°F (66°C)

## Heyco® Ergonomic Plugs for Square Tubing

### PSTE Series - Vinyl for Greater Flexibility

| TUBE DIMENSIONS<br>Inside |         |               |                        |         | PART NO.<br>Black | DESCRIPTION  | PART DIMENSIONS |      |      |      |
|---------------------------|---------|---------------|------------------------|---------|-------------------|--------------|-----------------|------|------|------|
| Dimension Range           |         | Typical Gauge | A<br>Outside Dimension |         |                   |              | B<br>Depth      |      |      |      |
| Minimum                   | Maximum |               | in.                    | mm.     |                   |              | in.             | mm.  |      |      |
| .58                       | 14,7    | .68           | 17,3                   | 14 - 20 | <b>G5320</b>      | PST E-75-14  | .75             | 19,1 | .43  | 10,9 |
| .73                       | 18,5    | .83           | 21,1                   | 10 - 14 | <b>G5321</b>      | PST E-100-10 | 1.00            | 25,4 |      |      |
| .83                       | 21,1    | .93           | 23,6                   | 14 - 20 | <b>G5322</b>      | PST E-100-14 |                 |      | 1.25 | 31,8 |
| 1.08                      | 27,4    | 1.18          | 30,0                   | 14 - 20 | <b>G5323</b>      | PST E-125-14 | 1.50            | 38,1 |      |      |
| 1.23                      | 31,2    | 1.33          | 33,8                   | 10 - 14 | <b>G5324</b>      | PST E-150-10 |                 |      |      |      |
| 1.33                      | 33,8    | 1.43          | 36,3                   | 14 - 20 | <b>G5325</b>      | PST E-150-14 | 2.00            | 50,8 |      |      |
| 1.73                      | 43,9    | 1.83          | 46,5                   | 14 - 20 | <b>G5326</b>      | PST E-200-10 |                 |      |      |      |

Standard color black.

## Heyco® Plugs for Rectangular Tubing

### PZT Series - Ribbed Fit

| TUBE DIMENSIONS         |         |                   |                  |              | PART NO.<br>Black | DESCRIPTION  | PLUG<br>Depth<br>C |     |      |
|-------------------------|---------|-------------------|------------------|--------------|-------------------|--------------|--------------------|-----|------|
| Outside Dimensions<br>A |         | Wall<br>Thickness | Typical<br>Gauge | B            |                   |              | in.                | mm. |      |
| in.                     | mm.     |                   |                  |              |                   |              | in.                | mm. | in.  |
| .50                     | 12,7    | 1.00              | 25,4             | .065 - .049  | 16 - 18           | <b>G5330</b> | PZT 50-100-16      | .43 | 10,9 |
|                         |         | 1.50              | 38,1             | .083 - .035  | 14 - 20           | <b>G5331</b> | PZT 50-150-14      | .50 | 12,7 |
| .63                     | 15,9    | 1.12              | 28,6             | .083 - .035  | 14 - 20           | <b>G5332</b> | PZT 63-112-14      | .43 | 10,9 |
|                         |         | 1.25              | 31,8             | .083         | 14                | <b>G5334</b> | PZT 63-125-14      | .50 | 12,7 |
| .75                     | 19,1    | 1.38              | 34,9             | .083 - .035  | 14 - 20           | <b>G5335</b> | PZT 63-138-14      | .43 | 10,9 |
|                         |         | 1.50              | 38,1             | .083 - .035  | 14 - 20           | <b>G5336</b> | PZT 75-150-14      | .43 | 10,9 |
| 1.00                    | 25,4    | 1.25              | 31,8             | .083 - .035  | 14 - 20           | <b>G5337</b> | PZT 100-125-14     | .50 | 12,7 |
|                         |         | 1.50              | 38,1             | .134 - .083  | 10 - 14           | <b>G5338</b> | PZT 100-150-10     |     |      |
|                         |         | 2.00              | 50,8             | .083 - .035  | 14 - 20           | <b>G5339</b> | PZT 100-150-14     |     |      |
|                         |         |                   |                  | .134 - .083  | 10 - 14           | <b>G5340</b> | PZT 100-200-10     |     |      |
|                         |         | 2.50              | 63,5             | .083 - .035  | 14 - 20           | <b>G5343</b> | PZT 100-250-14     | .45 | 11,4 |
|                         |         |                   |                  | .065 - .049  | 16 - 18           | <b>G5344</b> | PZT 100-250-16     | .50 | 12,7 |
| 3.00                    | 76,2    | .083 - .035       | 14 - 20          | <b>G5345</b> | PZT 100-300-14    | .51          | 13,0               |     |      |
| 1.50                    | 38,1    | 2.00              | 50,8             | .134 - .083  | 10 - 14           | <b>G5346</b> | PZT 150-200-10     | .50 | 12,7 |
|                         |         | 2.50              | 63,5             | .109 - .065  | 12 - 16           | <b>G5347</b> | PZT 150-250-12     | .53 | 13,5 |
|                         |         | 3.00              | 76,2             | .134 - .083  | 10 - 14           | <b>G5348</b> | PZT 150-300-10     | .50 | 12,7 |
|                         |         | 3.50              | 88,9             | .134 - .083  | 10 - 14           | <b>G5349</b> | PZT 150-350-10     | .60 | 15,2 |
| 1.96                    | 49,8    | 3.94              | 100,1            | .203 - .109  | 6 - 12            | <b>G5356</b> | PZT 196-394-06M    | .65 | 16,5 |
| 2.00                    | 50,8    | 2.50              | 63,5             | .134 - .083  | 10 - 14           | <b>G5351</b> | PZT 200-250-10     | .52 | 13,2 |
|                         |         | 3.00              | 76,2             | .203 - .165  | 6 - 8             | <b>G5352</b> | PZT 200-300-06     |     |      |
|                         |         |                   |                  | .134 - .083  | 10 - 14           | <b>G5353</b> | PZT 200-300-10     |     |      |
|                         |         | 4.00              | 101,6            | .083 - .035  | 14 - 20           | <b>G5354</b> | PZT 200-300-14     | .50 | 12,7 |
|                         |         |                   |                  | .203 - .120  | 6 - 11            | <b>G5355</b> | PZT 200-400-06     | .94 | 23,9 |
|                         |         | 5.00              | 127,0            | .134 - .083  | 10 - 14           | <b>G5357</b> | PZT 200-400-10     | .50 | 12,7 |
| .083 - .035             | 14 - 20 |                   |                  | <b>G5358</b> | PZT 200-400-14    |              |                    |     |      |
| 5.00                    | 127,0   | .165              | 8                | <b>G5359</b> | PZT 200-500-08*   | 1.00         | 25,4               |     |      |
|                         |         | .134              | 10               | <b>G5360</b> | PZT 200-500-10*   |              |                    |     |      |

Standard color black.

\*Smooth (ie, not ribbed) shank.

|                   |                                 |                   |                                  |
|-------------------|---------------------------------|-------------------|----------------------------------|
| Material          | <b>PSTE</b><br>Vinyl            | Material          | LDPE                             |
| Temperature Range | 26°F (-32°C) to<br>200°F (93°C) | Temperature Range | -94°F (-70°C) to<br>150°F (66°C) |



- **Flexible, ribbed design** allows quick and easy fingertip installation.
- **Removable without the use of tools** (Traditional glides and tube plugs are designed to be permanent. Their rigid design makes removal very difficult).
- Injection molded for intricate detail and design, with **flexibility**.
- See page 6-50 for HEYCaps and Plugs for Round Tubing.
- Material: Vinyl. Vinyl **decreases mobility** or sliding on floors, helping to keep your application in place.

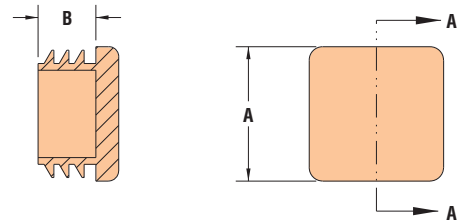

- Featuring the same external rib design of Heyco PSTR Series Plugs for Square Tubing, PZT Series Plugs for Rectangular Tubing are offered in a **broad selection of width-to-length proportions**, to fit many special tubing shapes found on stands for computer terminals, office machines, display fixtures, and similar metal furnishings and equipment.
- **Durable construction** ensures exceptional performance in business and commercial applications.

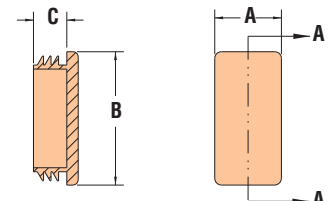



## Heyco® Stock and Custom\* Colors for Dome Plugs and Shorty Plugs

\*CUSTOM Color parts MUST be color matched. For accurate matching, consult Heyco for sample molded nylon color chips.

For complete Dome Plug Part Dimensions and Specifications, see page 6-25.

For complete Shorty Plug Part Dimensions and Specifications, see page 6-27.

- Heyco Stock and Custom Colors are Molded-in, not dyed, Colors.
- Stock and Custom Color Minimum Order Quantities are usually higher than for Black and White parts.
- **STOCK** Color means the color concentrate pellets are in stock at Heyco.
- The Stock Colors shown are **approximate**. Consult Heyco for Stock Color molded nylon color chips.
- Stock Color lead times are typically 2-3 weeks from receipt of order.
- For Stock Color part numbers in other Plug styles, for example Glossy or Double D Plugs, please consult Heyco.
- **CUSTOM** Color parts MUST be color matched to your application. For accurate matching, consult Heyco for sample molded nylon color chips.
- Custom Color lead times are typically 4 weeks from receipt of order.
- We offer Stock and Custom Colors in virtually all of our nylon molded products.
- Heyco's Axcell Rapid Response Team is ready to customize your Plug in various sizes, shapes, materials, and colors. We can even mold your Company logo directly onto your Plug!

| MOUNTING HOLE DIA. |       | PLUG TYPE | ROOT PART NO. | STOCK COLOR PART NUMBER SUFFIX |    |    |    |    |    |    |    |    |       | YOUR CUSTOM COLOR HERE |
|--------------------|-------|-----------|---------------|--------------------------------|----|----|----|----|----|----|----|----|-------|------------------------|
| in.                | mm.   |           |               | FK                             | FL | FJ | EH | CS | DD | CF | DQ | FI | xx ** |                        |
| .218               | 5,5   | Shorty    | 1656          | FK                             | FL | FJ | EH | CS | DD | CF | DQ | FI | xx    |                        |
| .250               | 6,4   | Dome      | 2605          | FK                             | FL | FJ | EH | CS | DD | CF | DQ | FI | xx    |                        |
| .281               | 7,1   | Shorty    | 1662          | FK                             | FL | FJ | EH | CS | DD | CF | DQ | FI | xx    |                        |
| .312               | 7,9   | Dome      | 2615          | FK                             | FL | FJ | EH | CS | DD | CF | DQ | FI | xx    |                        |
|                    |       | Shorty    | 1680          | FK                             | FL | FJ | EH | CS | DD | CF | DQ | FI | xx    |                        |
| .343               | 8,7   | Shorty    | 1665          | FK                             | FL | FJ | EH | CS | DD | CF | DQ | FI | xx    |                        |
|                    |       | Dome      | 2619          | FK                             | FL | FJ | EH | CS | DD | CF | DQ | FI | xx    |                        |
| .375               | 9,5   | Shorty    | 1683          | FK                             | FL | FJ | EH | CS | DD | CF | DQ | FI | xx    |                        |
|                    |       | Dome      | 2635          | FK                             | FL | FJ | EH | CS | DD | CF | DQ | FI | xx    |                        |
| .437               | 11,1  | Shorty    | 1686          | FK                             | FL | FJ | EH | CS | DD | CF | DQ | FI | xx    |                        |
|                    |       | Dome      | 2645          | FK                             | FL | FJ | EH | CS | DD | CF | DQ | FI | xx    |                        |
| .500               | 12,7  | Shorty    | 1689          | FK                             | FL | FJ | EH | CS | DD | CF | DQ | FI | xx    |                        |
|                    |       | Dome      | 2674          | FK                             | FL | FJ | EH | CS | DD | CF | DQ | FI | xx    |                        |
| .531               | 13,5  | Shorty    | 1674          | FK                             | FL | FJ | EH | CS | DD | CF | DQ | FI | xx    |                        |
| .562               | 14,3  | Dome      | 2655          | FK                             | FL | FJ | EH | CS | DD | CF | DQ | FI | xx    |                        |
| .625               | 15,9  | Dome      | 2665          | FK                             | FL | FJ | EH | CS | DD | CF | DQ | FI | xx    |                        |
|                    |       | Shorty    | 1692          | FK                             | FL | FJ | EH | CS | DD | CF | DQ | FI | xx    |                        |
| .687               | 17,4  | Dome      | 2675          | FK                             | FL | FJ | EH | CS | DD | CF | DQ | FI | xx    |                        |
|                    |       | Dome      | 2685          | FK                             | FL | FJ | EH | CS | DD | CF | DQ | FI | xx    |                        |
| .750               | 19,1  | Shorty    | 1695          | FK                             | FL | FJ | EH | CS | DD | CF | DQ | FI | xx    |                        |
|                    |       | Dome      | 2695          | FK                             | FL | FJ | EH | CS | DD | CF | DQ | FI | xx    |                        |
| .875               | 22,2  | Dome      | 2705          | FK                             | FL | FJ | EH | CS | DD | CF | DQ | FI | xx    |                        |
|                    |       | Shorty    | 1701          | FK                             | FL | FJ | EH | CS | DD | CF | DQ | FI | xx    |                        |
| 1.000              | 25,4  | Dome      | 2715          | FK                             | FL | FJ | EH | CS | DD | CF | DQ | FI | xx    |                        |
|                    |       | Shorty    | 1704          | FK                             | FL | FJ | EH | CS | DD | CF | DQ | FI | xx    |                        |
| 1.093-             | 27,8- | Dome      | 2725          | FK                             | FL | FJ | EH | CS | DD | CF | DQ | FI | xx    |                        |
| 1.125              | 28,6  | Shorty    | 1707          | FK                             | FL | FJ | EH | CS | DD | CF | DQ | FI | xx    |                        |
| 1.187              | 30,1  | Dome      | 2735          | FK                             | FL | FJ | EH | CS | DD | CF | DQ | FI | xx    |                        |
| 1.250              | 31,7  | Dome      | 2742          | FK                             | FL | FJ | EH | CS | DD | CF | DQ | FI | xx    |                        |
| 1.375              | 34,9  | Dome      | 2755          | FK                             | FL | FJ | EH | CS | DD | CF | DQ | FI | xx    |                        |
| 1.500              | 38,1  | Dome      | 2765          | FK                             | FL | FJ | EH | CS | DD | CF | DQ | FI | xx    |                        |
| 1.750              | 44,5  | Dome      | 2775          | FK                             | FL | FJ | EH | CS | DD | CF | DQ | FI | xx    |                        |
| 2.000              | 50,8  | Dome      | 2785          | FK                             | FL | FJ | EH | CS | DD | CF | DQ | FI | xx    |                        |
| 2.5                | 63,5  | Dome      | 2792          | FK                             | FL | FJ | EH | CS | DD | CF | DQ | FI | xx    |                        |
| 3.0                | 76,2  | Dome      | 2457          | FK                             | FL | FJ | EH | CS | DD | CF | DQ | FI | xx    |                        |

\*\* xx indicates that, following the color match process, Heyco will add a two letter suffix to the Root Part Number shown. This suffix will identify your particular CUSTOM Color selection. Consult Heyco for molded nylon color chips for accurate matching.



Your logo here



“Stay Connected” with



Hole Plugs & Venting Solutions

a PennEngineering® Company



## Heyco® Vent Plugs and Thick Panel Vent Plugs

Mounting Hole Diameter Range: .500" (12,7 mm) to 4.000" (101,6 mm)

| MOUNTING HOLE DIAMETER |     | PART NO. |       | DESCRIPTION | No. of Vent Holes | PART DIMENSIONS |                | B   |     |
|------------------------|-----|----------|-------|-------------|-------------------|-----------------|----------------|-----|-----|
| in.                    | mm. | Black    | White |             |                   | Head Diameter   | Overall Height | in. | mm. |

### Multiple Locking Steps for Panel Thickness up to .125" (3,2 mm)

|               |             |             |             |            |    |      |      |     |      |
|---------------|-------------|-------------|-------------|------------|----|------|------|-----|------|
| .500          | 12,7        | <b>2637</b> | <b>2638</b> | VP 500     | 4  | .56  | 14,2 | .41 | 10,3 |
| .562          | 14,3        | <b>2647</b> | -           | VP 562     | 4  | .66  | 16,7 |     |      |
| .625          | 15,9        | <b>2657</b> | <b>2658</b> | VP 625     | 5  | .73  | 18,7 |     |      |
| .750          | 19,1        | <b>2677</b> | <b>2678</b> | VP 750     | 8  | .91  | 23,0 |     |      |
| .812          | 20,6        | <b>2688</b> | <b>2689</b> | VP 812     | 8  | .89  | 22,6 |     |      |
| .875          | 22,2        | <b>2697</b> | <b>2698</b> | VP 875     | 9  | 1.02 | 25,8 | .45 | 11,5 |
| 1.000         | 25,4        | <b>2707</b> | <b>2708</b> | VP 1000    | 9  | 1.20 | 30,6 |     |      |
| 1.093 - 1.125 | 27,8 - 28,6 | <b>2726</b> | <b>2727</b> | VP 1093    | 9  | 1.22 | 30,9 |     |      |
| 1.187         | 30,1        | <b>2736</b> | <b>2737</b> | VP 1187    | 10 | 1.31 | 33,3 |     |      |
| 1.250         | 31,7        | <b>2743</b> | <b>2744</b> | VP 1250    | 10 | 1.38 | 34,9 |     |      |
|               |             | <b>2797</b> | -           | SVP 1250-4 | 4  |      |      |     |      |
| 1.375         | 34,9        | <b>2756</b> | <b>2757</b> | VP 1375    | 11 | 1.50 | 38,1 |     |      |
| 1.500         | 38,1        | <b>2766</b> | <b>2767</b> | VP 1500    | 13 | 1.67 | 42,4 |     |      |
| 1.750         | 44,5        | <b>2776</b> | <b>2777</b> | VP 1750    | 13 | 1.91 | 48,4 |     |      |
| 2.000         | 50,8        | <b>2786</b> | <b>2787</b> | VP 2000    | 19 | 2.14 | 54,4 |     |      |

### Multiple Locking Steps for Panel Thickness up to .250" (6,4 mm)

|               |             |             |             |          |    |      |       |     |      |     |      |
|---------------|-------------|-------------|-------------|----------|----|------|-------|-----|------|-----|------|
| .500          | 12,7        | <b>3010</b> | <b>3011</b> | VPT 500  | 4  | .58  | 14,7  | .56 | 14,3 |     |      |
| .625          | 15,9        | <b>3013</b> | <b>3014</b> | VPT 625  | 5  | .73  | 18,7  |     |      |     |      |
| .750          | 19,1        | <b>2426</b> | <b>2427</b> | VPT 750  | 8  | .91  | 23,0  |     |      |     |      |
| .875          | 22,2        | <b>3152</b> | <b>3153</b> | VPT 875  | 9  | 1.02 | 25,8  |     |      |     |      |
| 1.000         | 25,4        | <b>3154</b> | <b>3155</b> | VPT 1000 | 9  | 1.20 | 30,6  |     |      |     |      |
| 1.093 - 1.125 | 27,8 - 28,6 | <b>3032</b> | <b>3033</b> | VPT 1093 | 9  | 1.22 | 30,9  |     |      |     |      |
| 1.187         | 30,1        | <b>3160</b> | <b>3161</b> | VPT 1187 | 10 | 1.31 | 33,3  |     |      |     |      |
| 1.250         | 31,7        | <b>3034</b> | <b>3035</b> | VPT 1250 | 10 | 1.38 | 34,9  |     |      |     |      |
| 1.375         | 34,9        | <b>3036</b> | <b>3037</b> | VPT 1375 | 11 | 1.50 | 38,1  |     |      |     |      |
| 1.500         | 38,1        | <b>3156</b> | <b>3157</b> | VPT 1500 | 13 | 1.67 | 42,4  |     |      |     |      |
| 1.750         | 44,5        | <b>3038</b> | <b>3039</b> | VPT 1750 | 13 | 1.91 | 48,4  |     |      |     |      |
| 2.000         | 50,8        | <b>3158</b> | <b>3159</b> | VPT 2000 | 19 | 2.14 | 54,4  |     |      | .58 | 14,7 |
| 2.500         | 63,5        | <b>2793</b> | <b>2794</b> | VP 2.5   | 19 | 2.72 | 69,0  |     |      | .75 | 19,1 |
| 3.000         | 76,2        | <b>2458</b> | <b>2459</b> | VP 3.0   | 26 | 3.15 | 80,0  | .74 | 18,8 |     |      |
| 3.500         | 88,9        | <b>2467</b> | <b>2468</b> | VP 3.5   | 38 | 3.66 | 92,9  | .75 | 19,1 |     |      |
| 4.000         | 101,6       | <b>2476</b> | <b>2477</b> | VP 4.0   | 48 | 4.16 | 105,6 |     |      |     |      |

Standard color black. Consult Heyco for other colors.

- Permit the passage of air for ventilation and heat dissipation.
- Quick and easy installation with only fingertip pressure.
- Convex, matte finish head tapers to a thin edge.
- VP-500 through VP-875 have .094" (2,4 mm) diameter vent holes. All other sizes have .125" (3,2 mm) diameter vents.
- Lock firmly into panel up to .250" (6,4 mm) thick.
- Locking fingers in fractional increments up to the maximum panel thickness.
- Multiple sizes for use in .500" (12,7 mm) to 4.000" (101,6 mm) diameter holes.
- Approximate Head Thickness: .062" (1,6 mm). Thickness may vary.
- Heyco Louvered Plugs available, see page 6-56.

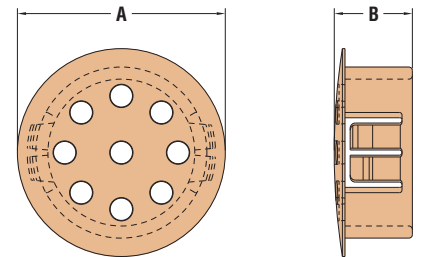

Material  
Certifications

Nylon 6/6

Recognized under the Component Program of Underwriters' Laboratories, File E51579

Certified by Canadian Standards Association, File 8919

Flammability Rating  
Temperature Range

94V-2

-40°F (-40°C) to 221°F (105°C)

Quick  
Specs



- Filter inserts permit the passage of air for ventilation but limit liquid as well as dust and pest infiltration.
- Polyurethane foam filter will filter particle sizes 30 micron and larger.
- Filter is captive in body of vent plug and uses no additional real estate inside.

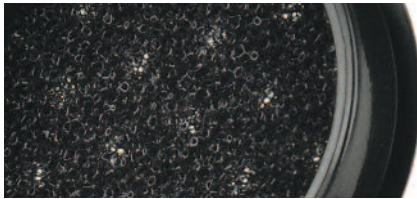

## HEYClean™ Filter Insert Vent Plugs

Mounting Hole Diameter Range: .500" (12,7 mm) to 3.000" (76,2 mm)

| MOUNTING HOLE DIAMETER  |                | PART NO.<br>Black | DESCRIPTION | No. of Vent Holes | PART DIMENSIONS    |      |                     |      |  |
|---|----------------|-------------------|-------------|-------------------|--------------------|------|---------------------|------|--|
| in.   | mm.            |                   |             |                   | A<br>Head Diameter |      | B<br>Overall Height |      |  |
|   |                |                   |             |                   | in.                | mm.  | in.                 | mm.  |  |
| Multiple Locking Steps for Panel Thickness up to .125" (3,2 mm) |                |                   |             |                   |                    |      |                     |      |  |
| .500  | 12,7           | 4917              | FIVP 500    | 4                 | .56                | 14,2 | .41                 | 10,4 |  |
| .875  | 22,2           | 4919              | FIVP 875    | 9                 | 1.02               | 25,8 | .45                 | 11,5 |  |
| 1.000   | 25,4           | 4921              | FIVP 1000   | 9                 | 1.20               | 30,6 |                     |      |  |
| 1.093 -<br>1.125  | 27,8 -<br>28,6 | 4923              | FIVP 1093   | 9                 | 1.22               | 30,9 |                     |      |  |
| 1.375   | 34,9           | 4931              | FIVP 1375   | 11                | 1.50               | 38,1 |                     |      |  |
| 1.500   | 38,1           | 4933              | FIVP 1500   | 13                | 1.67               | 42,4 |                     |      |  |
| 2.000   | 50,8           | 4937              | FIVP 2000   | 19                | 2.14               | 54,4 | .47                 | 11,9 |  |
| Multiple Locking Steps for Panel Thickness up to .250" (6,4 mm) |                |                   |             |                   |                    |      |                     |      |  |
| .875  | 22,2           | 4973              | FIVPT 875   | 9                 | 1.02               | 25,8 | .56                 | 14,3 |  |
| 1.000   | 25,4           | 4975              | FIVPT 1000  | 9                 | 1.20               | 30,6 |                     |      |  |
| 1.093 -<br>1.125  | 27,8 -<br>28,6 | 4977              | FIVPT 1093  | 9                 | 1.22               | 30,9 |                     |      |  |
| 1.375   | 34,9           | 4983              | FIVPT 1375  | 11                | 1.50               | 38,1 |                     |      |  |
| 1.500   | 38,1           | 4985              | FIVPT 1500  | 13                | 1.67               | 42,4 |                     |      |  |
| 2.000   | 50,8           | 4989              | FIVPT 2000  | 19                | 2.14               | 54,4 | .58                 | 14,7 |  |
| 2.500   | 63,5           | 4939              | FIVP 2.5    | 19                | 2.72               | 69,0 | .75                 | 19,1 |  |
| 3.000   | 76,2           | 4941              | FIVP 3.0    | 26                | 3.15               | 80,0 | .74                 | 18,8 |  |

Standard color black. Consult Heyco for other colors.

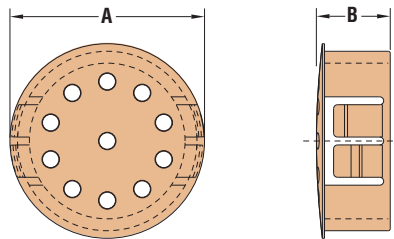

Quick  
Specs

|                     |                                |
|---------------------|--------------------------------|
| Material            | Nylon 6/6                      |
| Flammability Rating | 94V-2                          |
| Temperature Range   | -40°F (-40°C) to 221°F (105°C) |



## Heyco® Louvered Plugs

Mounting Hole Diameter Range: .875" (22,2 mm) to 3.000" (76,2 mm)

| MOUNTING HOLE DIAMETER  |             | PART NO.<br>Black | DESCRIPTION | PART DIMENSIONS    |      |                     |      |
|---|-------------|-------------------|-------------|--------------------|------|---------------------|------|
| in.   | mm.         |                   |             | A<br>Head Diameter |      | B<br>Overall Height |      |
| Multiple Locking Steps for Panel Thickness up to .125" (3,2 mm) |             |                   |             |                    |      |                     |      |
| .875  | 22,2        | 2557              | LP 875      | 1.02               | 25,8 | .53                 | 13,5 |
| 1.000   | 25,4        | 2559              | LP 1000     | 1.21               | 30,6 |                     |      |
| 1.093 - 1.125   | 27,8 - 28,6 | 2561              | LP 1093     | 1.22               | 30,9 |                     |      |
| 1.375   | 34,9        | 2567              | LP 1375     | 1.50               | 38,1 | .54                 | 13,8 |
| 1.500   | 38,1        | 2569              | LP 1500     | 1.68               | 42,6 |                     |      |
| 2.000   | 50,8        | 2594              | LP 2000     | 2.17               | 55,1 |                     |      |
| Multiple Locking Steps for Panel Thickness up to .250" (6,4 mm) |             |                   |             |                    |      |                     |      |
| 2.500   | 63,5        | 2596              | LP 2.5      | 2.72               | 69,0 | .82                 | 20,9 |
| 3.000   | 76,2        | 2598              | LP 3.0      | 3.17               | 80,5 |                     |      |

Standard color black. Consult Heyco for other colors.

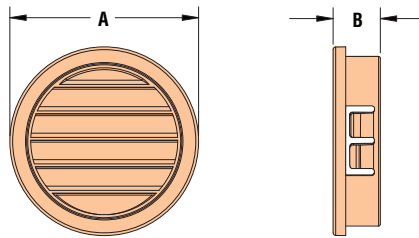

- Louvers permit the passage of air for ventilation but limit liquid infiltration.
- Suitable for ventilation in electronic enclosures, motor housings and metal or plastic panels.
- Quick and easy installation with flexible orientation of louver direction.
- Withstand a push back force of 35 lbs. (47 Nm).
- Lock firmly into panel up to .250" (6,4 mm) thick.
- Locking fingers in fractional increments up to the maximum panel thickness.
- Heyco Vent Plugs, Heyco Thick Panel Vent Plugs, and Heyco Liquid Tight Threaded Vent Plugs also available.

## HEYClean™ Filter Insert Louvered Plugs

Mounting Hole Diameter Range: .875" (22,2 mm) to 3.000" (76,2 mm)

| MOUNTING HOLE DIAMETER  |             | PART NO.<br>Black | DESCRIPTION | PART DIMENSIONS    |      |                     |      |
|---|-------------|-------------------|-------------|--------------------|------|---------------------|------|
| in.   | mm.         |                   |             | A<br>Head Diameter |      | B<br>Overall Height |      |
| Multiple Locking Steps for Panel Thickness up to .125" (3,2 mm) |             |                   |             |                    |      |                     |      |
| .875  | 22,2        | 4947              | FILP 875    | 1.02               | 25,8 | .53                 | 13,5 |
| 1.000   | 25,4        | 4949              | FILP 1000   | 1.21               | 30,6 |                     |      |
| 1.093 - 1.125   | 27,8 - 28,6 | 4951              | FILP 1093   | 1.22               | 30,9 |                     |      |
| 1.375   | 34,9        | 4957              | FILP 1375   | 1.50               | 38,1 | .54                 | 13,8 |
| 1.500   | 38,1        | 4959              | FILP 1500   | 1.68               | 42,6 |                     |      |
| 2.000   | 50,8        | 4963              | FILP 2000   | 2.17               | 55,1 |                     |      |
| Multiple Locking Steps for Panel Thickness up to .250" (6,4 mm) |             |                   |             |                    |      |                     |      |
| 2.500   | 63,5        | 4965              | FILP 2.5    | 2.72               | 69,0 | .82                 | 20,9 |
| 3.000   | 76,2        | 4967              | FILP 3.0    | 3.17               | 80,5 |                     |      |

Standard color black. Consult Heyco for other colors.



- Located behind the louvers, filter inserts permit the passage of air for ventilation but limit liquid as well as dust and pest infiltration.
- Polyurethane foam filter will filter particle sizes 30 micron and larger.

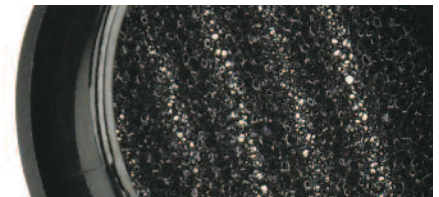

|                     |                                |
|---------------------|--------------------------------|
| Material            | Nylon 6/6                      |
| Flammability Rating | 94V-2                          |
| Temperature Range   | -40°F (-40°C) to 221°F (105°C) |

Quick Specs



- Permit the passage of air for ventilation and heat dissipation.
- Quick and easy installation into Threaded Holes.
- For multiple thread sizes and types.
- All sizes and types feature seven (7) .094" (2,4 mm) diameter vent holes.
- Threaded plugs for hydraulic and pneumatic applications.
- Lower cost option over brass or steel plugs.
- Non-corrosive-resist salt water, weak acids, gasoline, alcohol, oil, grease and common solvents. Resist oil and heat up to 221°F (105°C).
- Approximate Head Thickness: .21" (5,3 mm). Thickness may vary.
- Hex shaped head for wrench installation.
- Electrically non-conductive Nylon 6/6.
- For **Liquid Tight** Threaded Vent Plugs, see page 6-58.

## Heyco® Threaded Vent Plugs

Open vent holes only

| THREAD<br>Type/Size                                     | PART NO.     |             | DESCRIPTION | PART DIMENSIONS                   |      |                                  |      |
|---|--------------|-------------|-------------|-----------------------------------|------|----------------------------------|------|
|   | Black        | Gray        |             | A<br>Wrenching Flats<br>in.   mm. |      | B<br>Overall Length<br>in.   mm. |      |
| <b>NPT</b>  |              |             |             |                                   |      |                                  |      |
| NPT 1/4   | <b>3551B</b> | <b>3551</b> | TVP NPT 1/4 | .63                               | 16,0 | .66                              | 16,8 |
| NPT 3/8   | <b>3552B</b> | <b>3552</b> | TVP NPT 3/8 | .83                               | 21,0 | .69                              | 17,5 |
| NPT 1/2   | <b>3553B</b> | <b>3553</b> | TVP NPT 1/2 | .98                               | 24,9 | .81                              | 20,6 |
| NPT 3/4   | <b>3554B</b> | <b>3554</b> | TVP NPT 3/4 | 1.29                              | 32,8 | .86                              | 21,8 |
| <b>PG - for PG Thread specifications, see page 3-49</b> |              |             |             |                                   |      |                                  |      |
| Pg 7  | <b>3566B</b> | <b>3566</b> | TVP Pg 7    | .63                               | 16,0 | .53                              | 13,5 |
| Pg 9  | <b>3567B</b> | <b>3567</b> | TVP Pg 9    | .83                               | 21,0 | .62                              | 15,8 |
| Pg 13.5   | <b>3568B</b> | <b>3568</b> | TVP Pg 13.5 | .98                               | 24,9 | .76                              | 19,3 |
| Pg 21   | <b>3569B</b> | <b>3569</b> | TVP Pg 21   | 1.29                              | 32,8 | .76                              | 19,3 |
| <b>Metric</b>   |              |             |             |                                   |      |                                  |      |
| M12   | <b>3557B</b> | <b>3557</b> | TVP M12     | .63                               | 16,0 | .53                              | 13,5 |
| M16   | <b>3558B</b> | <b>3558</b> | TVP M16     | .83                               | 21,0 | .62                              | 15,8 |
| M20   | <b>3559B</b> | <b>3559</b> | TVP M20     | .98                               | 24,9 | .62                              | 15,8 |

Standard color Black. Consult Heyco for other colors.

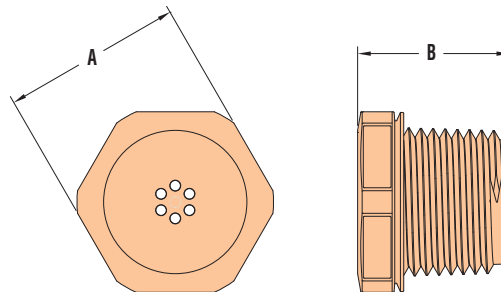

*Quick  
Specs*

|                     |                                      |
|---------------------|--------------------------------------|
| Material            | Nylon 6/6 bodies with UL (f1) rating |
| Flammability Rating | 94V-2                                |
| Temperature Range   | -40°F (-40°C) to 221°F (105°C)       |

“Stay Connected” with



Hole Plugs & Venting Solutions

a PennEngineering® Company

NO O-RING  
REQUIRED!



## HEYClean™ Liquid Tight Threaded Vent Plugs

With Integral Sealing Ring and Liquid Tight Filter

| THREAD<br>Type/Size                                     | PART NO. |        | DESCRIPTION   | PART DIMENSIONS                 |      |                                |      |
|---|----------|--------|---------------|---------------------------------|------|--------------------------------|------|
|   | Black    | Gray   |               | A<br>Wrenching Flats<br>in. mm. |      | B<br>Overall Length<br>in. mm. |      |
| <b>NPT</b>  |          |        |               |                                 |      |                                |      |
| NPT 1/4   | 3544VB   | 3544V  | LTTVP NPT 1/4 | .63                             | 16,0 | .66                            | 16,8 |
| NPT 3/8   | 3545VB   | 3545V  | LTTVP NPT 3/8 | .83                             | 21,0 | .69                            | 17,5 |
| NPT 1/2   | 3546VB   | 3546V  | LTTVP NPT 1/2 | .98                             | 24,9 | .81                            | 20,6 |
| NPT 3/4   | 3547VB*  | 3547V* | LTTVP NPT 3/4 | 1.29                            | 32,8 | .86                            | 21,8 |
| <b>PG - For PG Thread specifications, see page 3-49</b> |          |        |               |                                 |      |                                |      |
| Pg 7  | 3574VB   | 3574V  | LTTVP Pg 7    | .63                             | 16,0 | .53                            | 13,5 |
| Pg 9  | 3575VB   | 3575V  | LTTVP Pg 9    | .83                             | 21,0 |                                |      |
| Pg 13.5   | 3576VB   | 3576V  | LTTVP Pg 13.5 | .98                             | 24,9 | .62                            | 15,8 |
| Pg 21   | 3401VB   | 3401V  | LTTVP Pg 21   | 1.29                            | 32,8 | .76                            | 19,3 |
| <b>Metric</b>   |          |        |               |                                 |      |                                |      |
| M12   | 3582VB   | 3582V  | LTTVP M12     | .63                             | 16,0 |                                |      |
| M16   | 3583VB   | 3583V  | LTTVP M16     | .83                             | 21,0 | .53                            | 13,5 |
| M20   | 3584VB   | 3584V  | LTTVP M20     | .98                             | 24,9 | .62                            | 15,8 |

Standard color Black. Consult Heyco for other colors.

\*IP 65 rated.

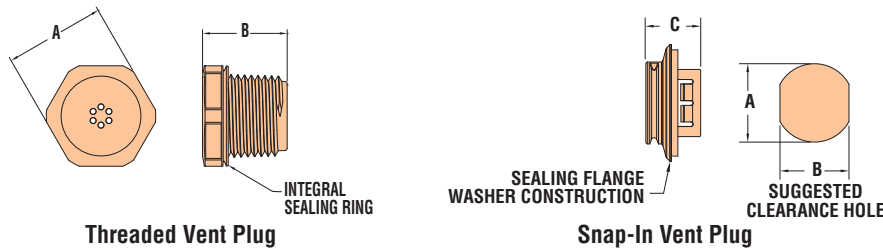

- Integral sealing ring ensures a **superior seal** at mounting hole location, every time; **IP 65, 67 and 68 Rated**.
- Allow the passage of air for ventilation and heat dissipation, yet prevent moisture intrusion, remain liquid tight.
- Maximum airflow:  $\geq 16.6$  LPM/3.7cm<sup>2</sup> @ 13.5 psi.
- UL Rated for Type NEMA 3R, 4, and 4X applications.
- Filter membrane prevents moisture and particulate contamination in electronic enclosures.
- Pressure compensating seal prevents buildup of pressure inside of electronic enclosures due to environmental temperature cycling.
- Quick and easy installation into Threaded (LTTVP) and Clearance (LTSV) holes.
- Membrane seal is ultrasonically welded to nylon body.
- Lower cost option over metal or steel plugs.
- Approximate Head Thickness: .21" (5,3 mm). Thickness may vary.
- Hex shaped head for wrench installation (LTTVP only).
- Electrically non-conductive Nylon 6/6.
- Quick and easy **Snap-in** installation into Clearance Holes.
- All sizes and types feature (9) .094" (2,4 mm) diameter vent holes.
- **Snap-In** plugs for panel and housing applications.
- Lower cost option over brass or steel plugs.
- Snap into a range of panel thicknesses up to .125" (3,2 mm) with no tools (LTSV only).

## HEYClean™ Liquid Tight Snap-In Vent Plugs

With Integral Sealing Flange/Washer and Liquid Tight Filter

Mounting Hole Diameter Range: .500" (12,7 mm) to 1.125" (28,6 mm)

| A<br>Mounting Hole Dia.* | PART NO. | DESCRIPTION | PART DIMENSIONS          |      |                       |      |
|--------------------------|----------|-------------|--------------------------|------|-----------------------|------|
|                          |          |             | B<br>To Prevent Rotation |      | C<br>Max. O.A. Length |      |
| in. mm.                  | Black    |             | in.                      | mm.  | in.                   | mm.  |
| .500 12,7                | 3481VB   | LTSV 500    | .45                      | 11,4 | .600                  | 15,2 |
| .875 22,2                | 3486VB   | LTSV 875    | .77                      | 19,6 | .620                  | 15,7 |
| 1.125 28,6               | 3488VB   | LTSV 1125   | 1.00                     | 25,4 | .660                  | 16,8 |

Standard color black. Consult Heyco for other colors.

\* Consult Heyco for additional sizes.

|                     |   |
|---------------------|---|
| Material            | Nylon 6/6 bodies with an Acrylic Copolymer Filter   |
| Certifications      | Recognized under the Component Program of Underwriters' Laboratories, File E330194 to both Canadian and U.S. Requirements |
| Flammability Rating | 94V-2   |
| Temperature Range   | -40°F (-40°C) to 221°F (105°C)  |
| IP Rating           | IP 65/67/68   |

Quick  
Specs



**Pressure Equalization Plugs**

- Allow the passage of air for ventilation and heat dissipation, yet prevent moisture intrusion.
- Filter membrane prevents moisture and particulate contamination in electronic enclosures.
- Pressure compensating seal prevents buildup of pressure inside of electronic enclosures due to environmental temperature cycling.
- Quick and easy installation into Clearance or Threaded Holes.
- **Nickel-plated finish over brass provides excellent corrosion resistance and durability.**
- Head Thickness: .37” (9,5 mm) to .39” (10 mm).
- Hex shaped body for wrench installation.
- Filter element:  
Liquid Tight Membrane: Polyethersulfone (PES)  
Sintered Disc: Bronze
- DFARS Compliant

**Drain Plugs**

- Drainage Plugs are ideal for applications where condensation is expected.
- Stainless steel mesh allows water to drain quickly, but protects enclosure from bugs and dust.
- Drainage Plugs feature a “cutout” section to allow water to completely drain from enclosure, and should be installed at enclosure’s lowest point.
- Head Thickness: .37” (9,5 mm) to .39” (10 mm).
- Hex shaped body for wrench installation.
- DFARS Compliant

**Drain Plug Locknuts**

- Quick and easy installation into Clearance Holes only.
- Locknuts feature special “cutout” to allow water to completely drain from enclosure, when used with HEYClean™ Threaded Drain Plugs.
- DFARS Compliant

**HEYClean® Brass Pressure Equalization and Drain Plugs**

For Pressure Equalization and Drainage Applications

| THREAD<br>Type/Size | PART NO. |      | DESCRIPTION | PART DIMENSIONS     |     |                     |     |                    |     |                      |     | PROTECTION CLASS |
|---------------------|----------|------|-------------|---------------------|-----|---------------------|-----|--------------------|-----|----------------------|-----|------------------|
|                     | STD.     | EXP* |             | A<br>Clearance Hole |     | B<br>Overall Length |     | C<br>Thread Length |     | D<br>Wrenching Flats |     |                  |
|                     |          | NEW  |             | in.                 | mm. | in.                 | mm. | in.                | mm. | in.                  | mm. |                  |

**Liquid Tight Pressure Equalization Plugs – Ultimate in Liquid Tight Pressure Equalization**

|           |      |       |                 |     |      |     |      |     |     |     |      |             |
|-----------|------|-------|-----------------|-----|------|-----|------|-----|-----|-----|------|-------------|
| M12 x 1.5 | 4350 | 14350 | BRASS LTPEP M12 | .47 | 12,0 | .69 | 17,5 | .31 | 8,0 | .71 | 18,0 | IP 66,67,68 |
| M16 x 1.5 | 4351 | 14351 | BRASS LTPEP M16 | .63 | 16,0 | .71 | 18,0 | .31 | 8,0 | .87 | 22,0 |             |
| M20 x 1.5 | 4352 | 14352 | BRASS LTPEP M20 | .79 | 20,0 | .71 | 18,0 | .31 | 8,0 | .87 | 22,0 |             |

**Liquid Resistant Pressure Equalization Plugs – Maximize Airflow for Extreme Pressure and Moisture Fluctuations**

|           |      |   |                 |     |      |     |      |     |     |     |      |            |
|-----------|------|---|-----------------|-----|------|-----|------|-----|-----|-----|------|------------|
| M12 x 1.5 | 4354 | – | BRASS LRPEP M12 | .47 | 12,0 | .69 | 17,5 | .31 | 8,0 | .71 | 18,0 | IP 55, x9K |
| M16 x 1.5 | 4355 | – | BRASS LRPEP M16 | .63 | 16,0 | .71 | 18,0 | .31 | 8,0 | .87 | 22,0 |            |
| M20 x 1.5 | 4356 | – | BRASS LRPEP M20 | .79 | 20,0 | .71 | 18,0 | .31 | 8,0 | .87 | 22,0 |            |

**Threaded Drain Plug – For Applications Where Condensation Is Expected\*\***

|           |      |   |               |     |      |     |      |     |      |     |      |       |
|-----------|------|---|---------------|-----|------|-----|------|-----|------|-----|------|-------|
| M12 x 1.5 | 4357 | – | BRASS TDP M12 | .47 | 12,0 | .77 | 19,5 | .39 | 10,0 | .71 | 18,0 | IP 4x |
| M16 x 1.5 | 4358 | – | BRASS TDP M16 | .63 | 16,0 | .79 | 20,0 | .39 | 10,0 | .87 | 22,0 |       |
| M20 x 1.5 | 4359 | – | BRASS TDP M20 | .79 | 20,0 | .79 | 20,0 | .39 | 10,0 | .87 | 22,0 |       |

Stainless Steel available. Consult Heyco.

\*Certified in accordance with IECEx and ATEX

\*\*Heyco Drainage Plug Brass Locknuts sold separately

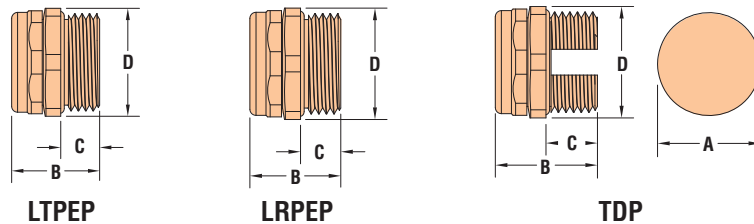

**HEYClean® Drain Plug Brass Locknuts**

For Use with HEYClean™ Threaded Drain Plugs

| THREAD<br>Type/Size | PART NO. | DESCRIPTION    | PART DIMENSIONS |     |                      |      |
|---------------------|----------|----------------|-----------------|-----|----------------------|------|
|                     |          |                | A<br>Thickness  |     | B<br>Wrenching Flats |      |
|                     |          |                | in.             | mm. | in.                  | mm.  |
| M12 x 1.5           | 4360     | BRASS DPLN M12 | .18             | 4,5 | .59                  | 15,0 |
| M16 x 1.5           | 4361     | BRASS DPLN M16 | .22             | 5,5 | .75                  | 19,0 |
| M20 x 1.5           | 4362     | BRASS DPLN M20 | .22             | 5,5 | .94                  | 24,0 |

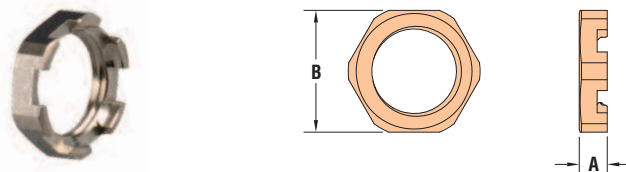

|                   |   |
|-------------------|---|
| Material          | Nickel-Plated Brass   |
| Temperature Range | -40°F (-40°C) to 230°F (110°C)  |
| IP Rating         | Membrane - IP66/IP68/IP69<br>Filter Disc - IP55/ IPX9K<br>Drainage Element - IP4X |